

Installation instructions for CB-radio

Notice de montage pour émetteur/récepteur SRG

244, 264

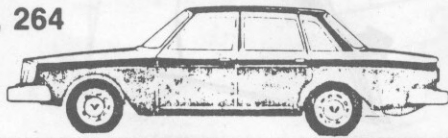

1

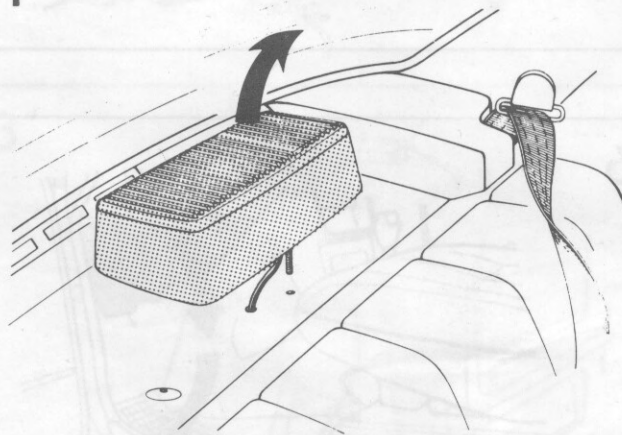

2

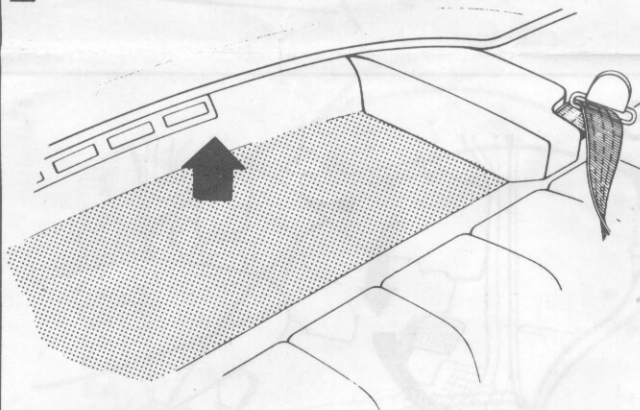

3

4 × Ø 3,5 mm

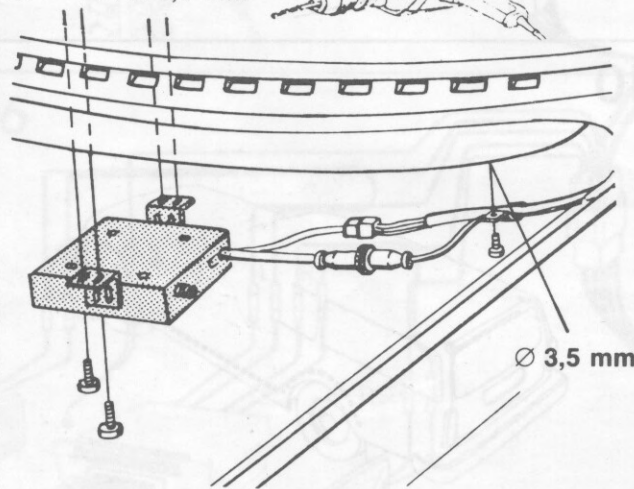

245, 265

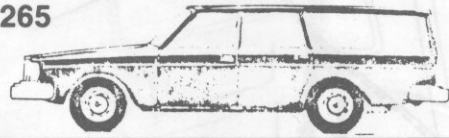

1

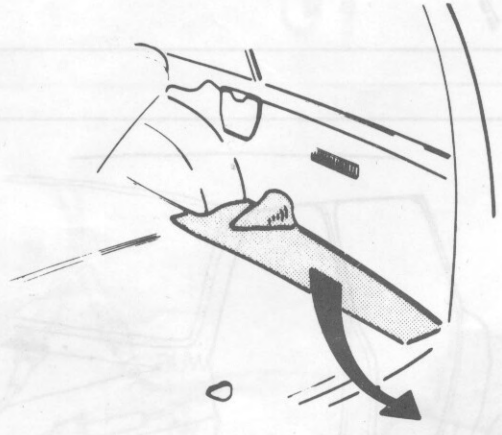

2

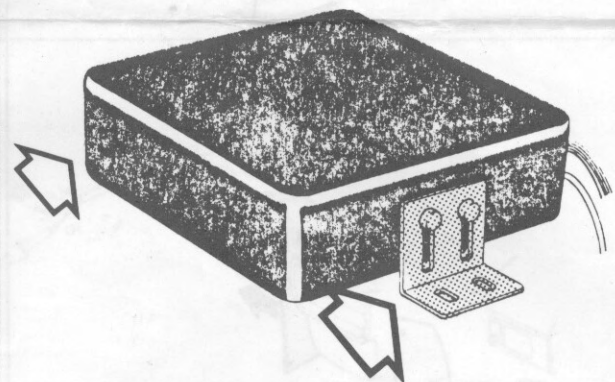

3

4 × Ø 3,5 mm

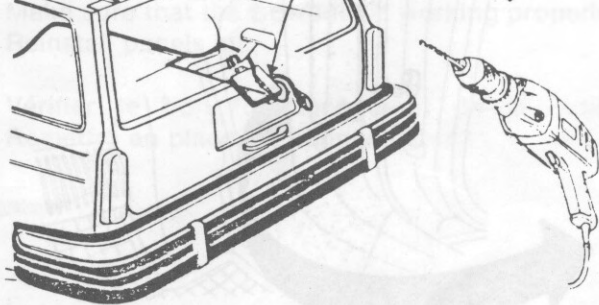
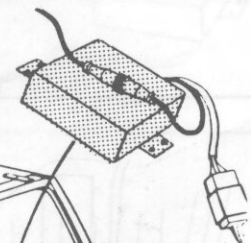

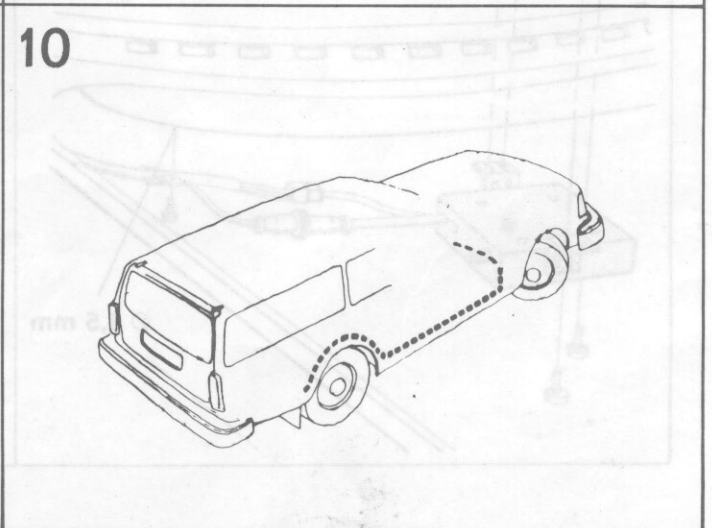
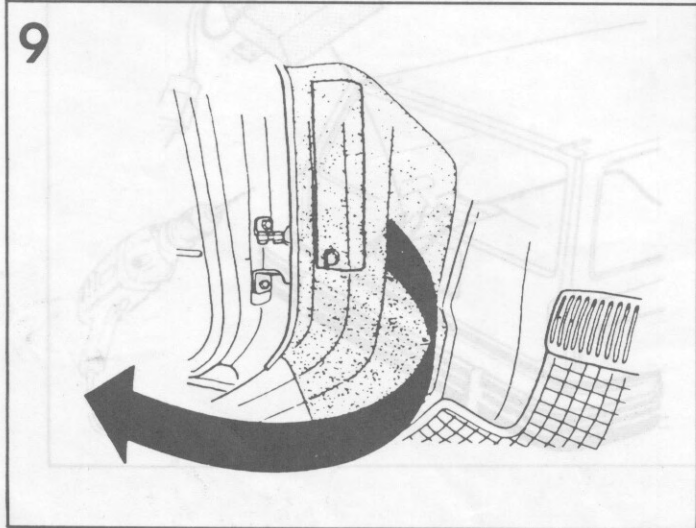
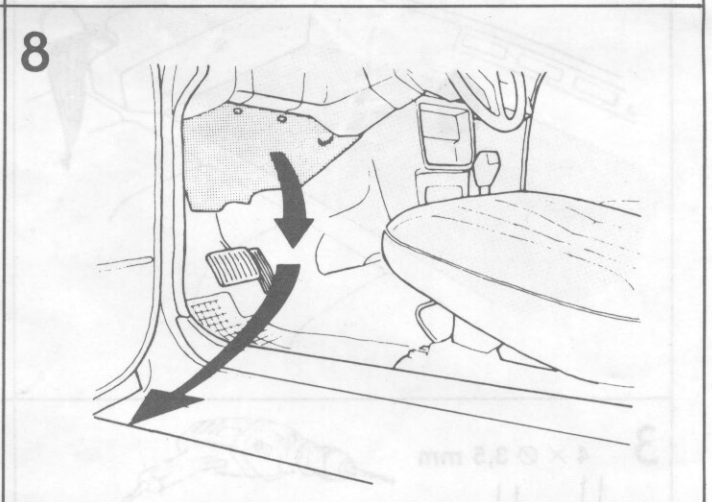
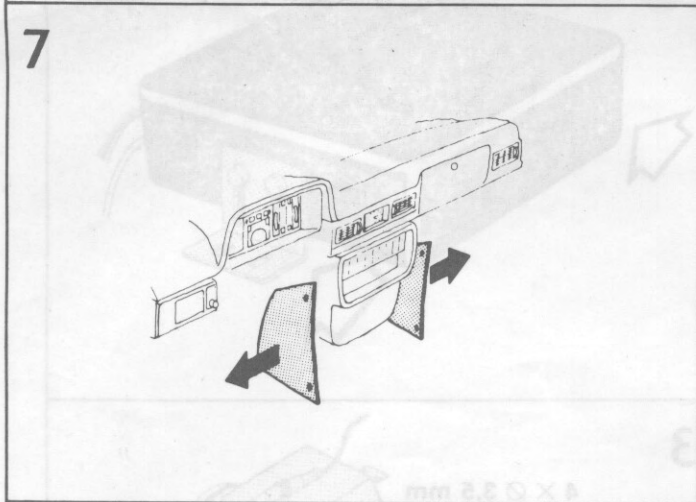
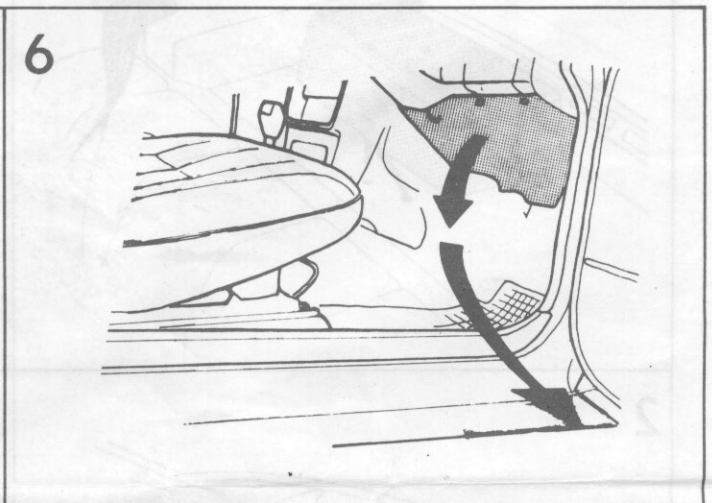
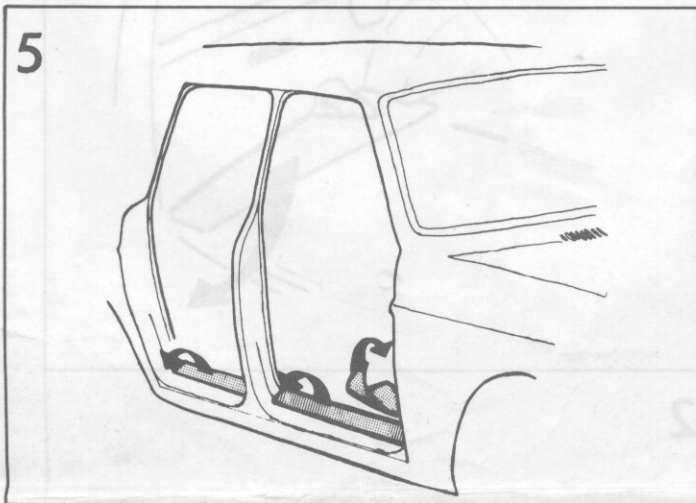
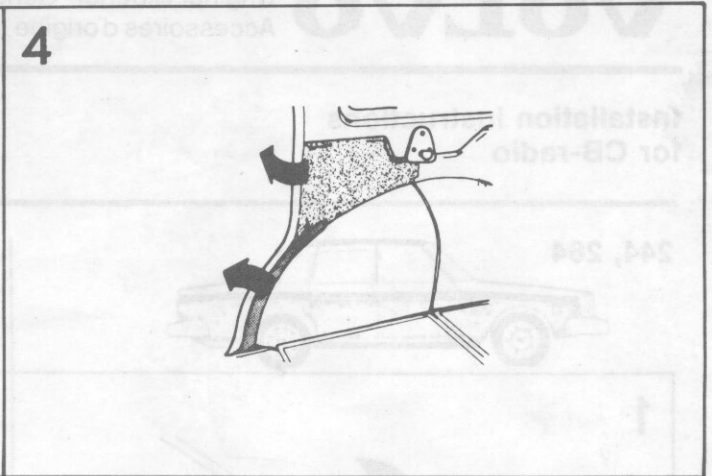
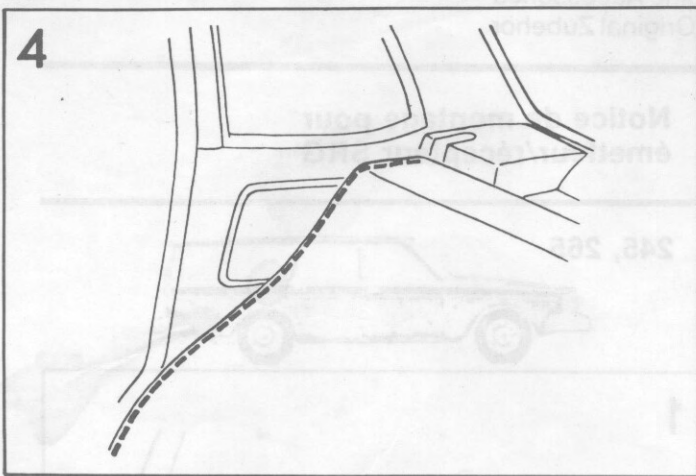

11

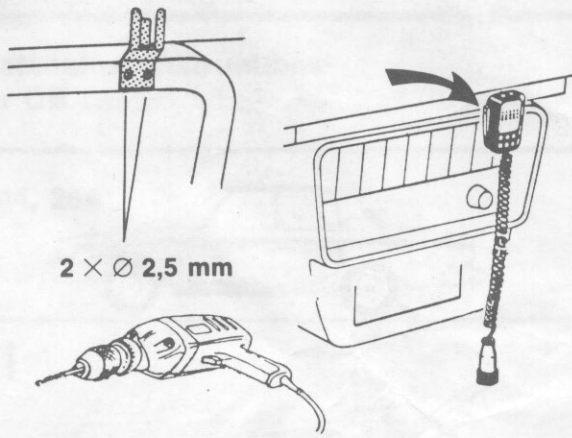

12

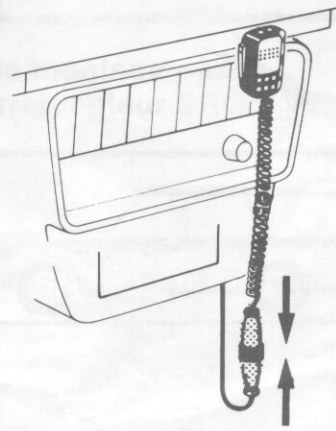

13

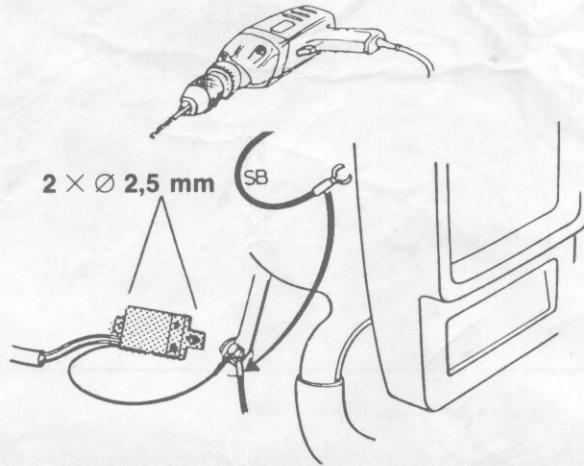

14

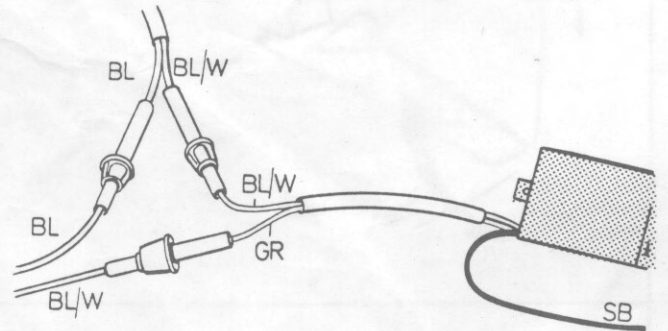

15

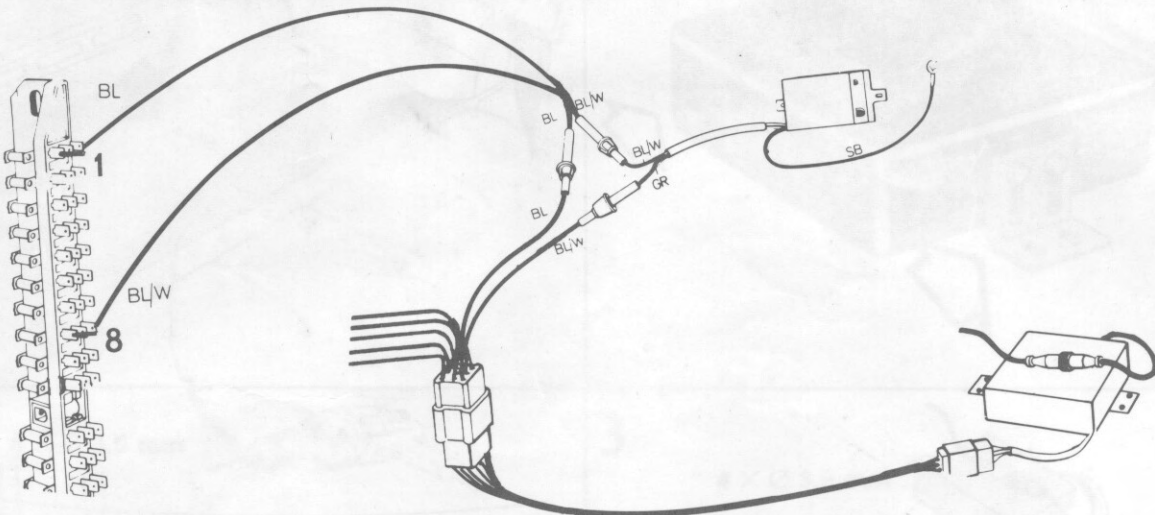

16

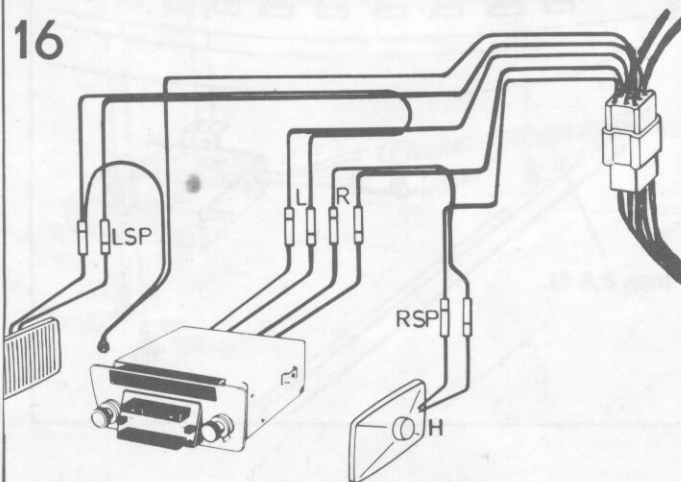

17

Make sure that the CB-radio is working properly.
Reinstall panels etc.

Vérifier le bon fonctionnement de la radio.
Remettre en place les panneaux etc .

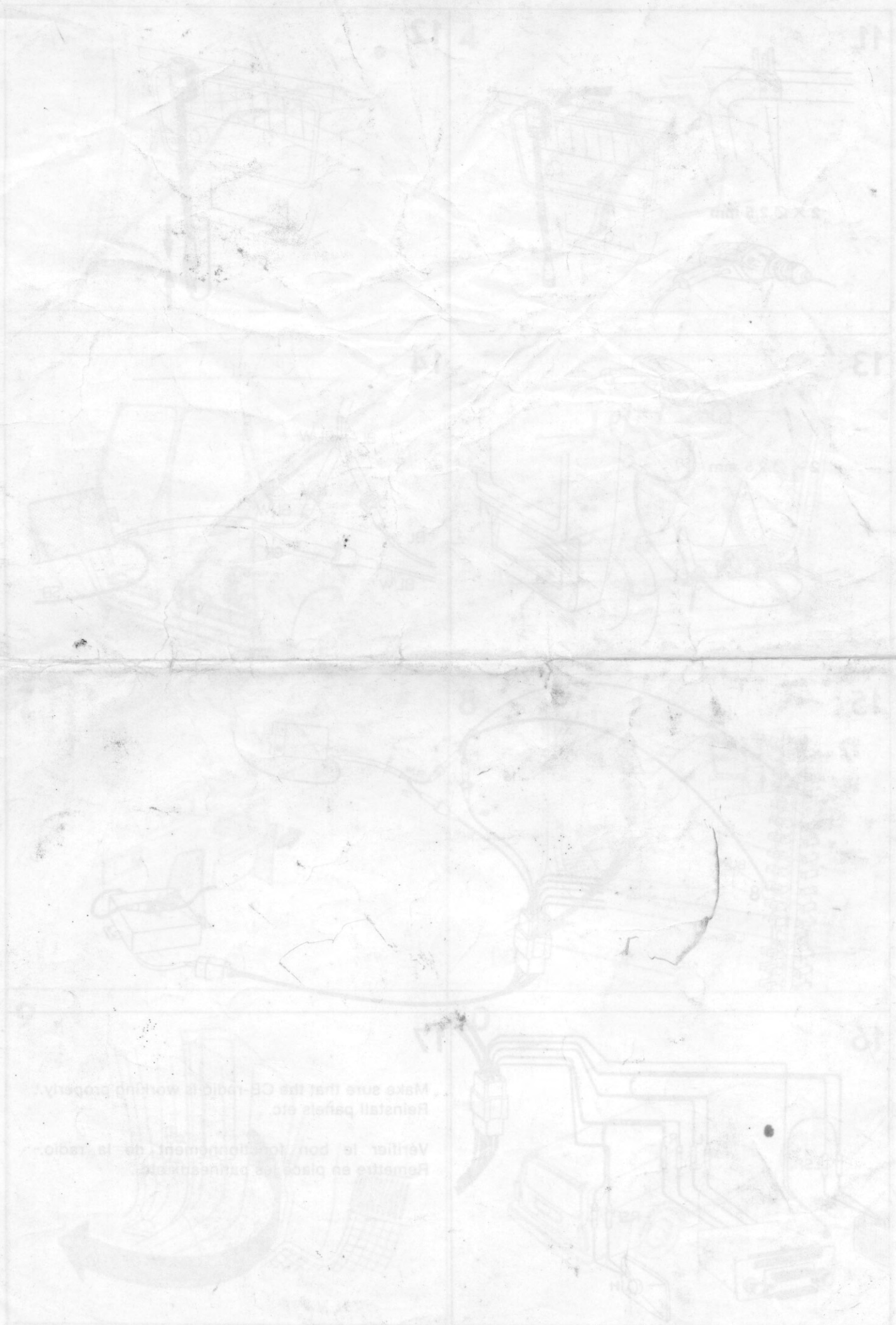

Make sure that the CB radio is working properly.
 Reinstall panels etc.
 Vérifier le bon fonctionnement de la radio.
 Remettez en place les panneaux etc.