

**VOLVO**

**performance parts  
and GT accessories**



**VOLVO**

**R**  
**SPORT**



## INTRODUCTION

Volvo R Sport—A new name representing a new era in Volvo performance and competition. Volvo's long established competition department in Gothenburg, Sweden, formerly known as Volvo Competition Service, has adopted the new name to reflect the expanded development program of competition parts and equipment to support both the Volvo enthusiast and the official factory re-entry into competition—the Volvo R Team.

The Volvo R Team (the R is for rally and racing) represents Volvo's official return to rally racing with two specially prepared Volvo 343 Turbo's competing in the European Rally Cross Championships during 1979.

The "Team" is the final test for parts and equipment developed and marketed by the "Sport" division, a combination that assures the Volvo enthusiast and competitor the finest in performance parts and GT accessories.

The Parts and Accessories Division of Volvo of America began distribution of competition parts back in 1974 from the Los Angeles Distribution Center. Since then, it has expanded into a national program that allows all Volvo dealers in the U.S. and Canada immediate access to these parts through their local Volvo Parts Distribution Centers.

Although Volvo of America does not actively participate in competition, Volvo has established a specialist to assist the dealer, competitor, and enthusiast in the application and preparation of performance parts and accessories.

In the U.S. write:  
Volvo of America Corp.  
Parts Division  
Building C  
Rockleigh, N.J. 07647

In Canada write:  
Volvo Canada Ltd.  
Parts Division  
175 Gordon Baker Road  
Willowdale, Ontario  
M2H 2N7

The extensive technical resources of both the R Sport Department and other technical units within Volvo provide the important support to the specialist to assure that the most current and accurate information is available to the enthusiast and competitor.

The success of Volvo in European type performance rallies here in America attests to the importance of using the right parts and applications. Some of the best performance rally drivers in North America depend on Volvo, and consistently place in the top positions, often ahead of factory prepared cars costing five times as much.

In fact, the Volvo 142 may be one of the least expensive cars to prepare for competition. Volvo's legendary strength and durability means relatively little modification when compared to other manufacturers. Yet, the parts and equipment listed within these pages allows you to prepare a car identical to one our factory would build. Everything from GT stripes to specially cast, limited production, large port cylinder heads.

Like all genuine Volvo parts, performance parts and GT accessories are protected by a limited 12 month warranty against defects in material and workmanship.

This coverage, however, does not apply to any part actually used in performance rally or race-like competition.

All items listed in this catalog may only be purchased from an authorized Volvo dealer. Price information can be obtained from any Volvo dealer.

Volvo competitors in rally and racing can find individual competition maintenance and replacement parts listed in the Master Volvo R Sport (formerly Competition Service) catalog, available at the Parts Department of an authorized Volvo dealer.

Whether competing in rally and racing or just seeking improved performance for everyday use, Volvo Performance Parts and GT Accessories are designed to make your Volvo that much more rewarding and enjoyable to drive.

---

**IMPORTANT NOTE: Many of the competition R Sport parts are intended strictly for off road competition use and are not certified or approved by the U.S. Environmental Protection Agency (EPA) the National Highway and Traffic Safety Administration (NHTSA), or Transport Canada.**

**Volvo dealers in the United States may be subject to legal penalties under The Clean Air Act and/or The National Traffic and Motor Vehicle Safety Act if they fail to advise customers of possible Federal and State violations before the sale or installation of subject parts.**

**In Canada, Volvo dealers may be subject to penalties under certain provincial laws and regulations if they fail to advise customers of possible violations before the sale or installation of subject parts.**

**Additionally, the owner and/or operator of a vehicle used on public roads and equipped with parts in violation of standards set forth by government agencies, may be subject to the same legal penalties.**

---

## CONTENTS

Engine Tuning Kits	3,4
GT	3
Stage I	3
Stage II, III, IV	4
Cylinder Heads	5
Valves & Springs	6
Camshafts and Lifters	7, 8
Engine Parts	9, 10
Pistons, Timing Gears, Seals	9
Flywheels, Oil Coolers	10
Fuel/Induction Systems	11, 12, 13
Solex Side Draft Carburetor Kit	11
Solex Jets	12
Miscellaneous Parts	13
Exhaust System & Manifolds	14
Electrical Equipment	15, 16, 17, 18
Instruments	15
Ignition	15
Lighting	16, 17
Miscellaneous	18
Power Train	19, 20, 21
Close-ratio Gears	19
Heavy Duty Clutch & Drive Train	20
Rear Axle Gears & Limited-Slip	21
Suspension	22, 23, 24, 25, 26
Handling Kits	22
Shock Absorbers	23, 24
Anti-sway Bars	25
Springs	26
Wheels	27
Heavy Duty Parts	27
Body	28, 29
Protection Plates	28
Spoilers	28
Stripes	29
Miscellaneous Accessories	30, 31, 32, 33
Steering Wheels & Interior	30
Jackets & Sweaters	31
T-Shirts & Badges	32
Safety Helmets	33



# VOLVO engine B18/B20

## PERFORMANCE TUNING KITS

### GT Tuning Kit

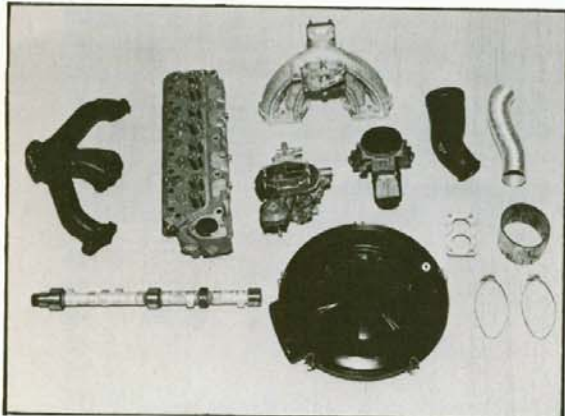

The ideal kit for upgrading the power of the B18/B20 engine intended primarily for street use. When installed on the older B18, the engine should be rebored to B20 specs (3.5" bore) using std. B20 pistons. The kit features a specially cast cylinder head of 10.5:1 compression ratio that utilizes larger ports and valves for increased flow. This, coupled along with the high-lift camshaft and new single, down-draft dual throat carburetor results in approximately 130 h.p. DIN at 6000 RPM. The GT kit is the perfect solution when overhauling a worn engine. Rather than rebuild the original cylinder head and fuel intake system, simply upgrade the entire top half by installing the new GT kit. Complete with all nuts, bolts, gaskets, and installation instructions.

Part No.	Description	Model Application
552550-6	GT Kit	1966-75 B18/B20

Horsepower: 130 DIN at 6000 RPM  
Torque: 131 Lb Ft at 3500 RPM  
Compression Ratio: 10.5:1  
Camshaft: "K"

### Stage I & II Tuning Kits

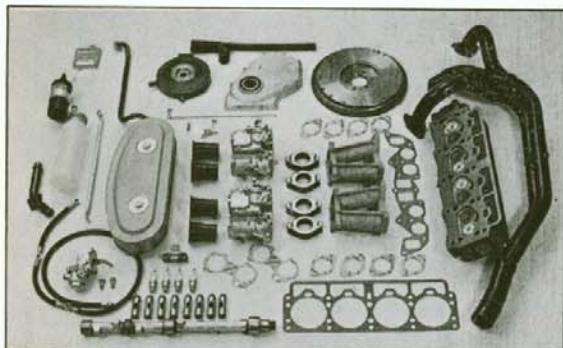

Sophisticated kits designed primarily for competition use. Both kits feature two twin choke 45mm side-draft Solex carburetors (aluminum body) coupled with two individual aluminum intake manifolds. Specially cast cylinder head and camshaft along with a 4 branch steel exhaust extractor manifold provides maximum horsepower and torque with excellent throttle response. Although more complex than the GT Tuning Kit, Stage Tuning Kits are built for very rugged driving conditions (off-road racing) so that very little service is needed. Ideal for performance rally, road racing, or spirited street driving.

#### Stage I

Part No.	Description	Model Application
552861-7	Stage I Kit	1966-73 B18*/B20
552470-7	Stage I Kit	1974-75 B20

Horsepower: 145 DIN at 6000 RPM  
Torque: 142 Lb Ft at 4500 RPM  
Compression Ratio: 10.5:1  
Camshaft: "F"

\*B18 should be overbored to B20 specs for effective utilization of Stage Kits.

# engine B18/B20

## Stage II

Part No.	Description	Model Application
552863-3	Stage II Kit	1966-73 B18*/B20
552472-3	Stage II Kit	1974-75 B20

Horsepower: 165 DIN at 6000 RPM  
Torque: 150 Lb Ft at 4700 RPM  
Compression Ratio: 11.0:1  
Camshaft: "F"

Stage II is essentially the same as Stage I, but with the following exceptions:

Part No.	Qty.	Description
552423-6	1	Special cylinder head with modified valves and lower valve spring seats for high lift cam
552841-9	8	Lightened valve lifters
552029-1	4	Bosch 280S1S spark plugs (cold)
942058-9	10	Hardened washers for cylinder head bolts

\* overbore to B20 spec.

## Stage III

Horsepower: 175 DIN at 6250 RPM  
Torque: 154 Lb Ft at 4500 RPM  
Compression Ratio: 11.0:1  
Camshaft: "R"

Stage III is not sold as an entire kit. Instead the following parts must be substituted with those in Stage II.

Part No.	Qty	Description
552432-7	1	Special cylinder head with larger polished ports and valves (see page 5 for specs)
552499-6	4	Racing Bosch spark plug 310SIS
552430-1	1	Camshaft "R" (see page 7 for specs)
552613-2	1	Polished & ground front intake manifold
552614-0	1	Polished & ground rear intake manifold
552004-4	1	Extra capacity electric fuel pump
1155255-1	1	40mm carburetor venturi kit with jets
552900-3	1	13 tube oil cooler complete with hose and adaptor plate

## Stage IV

Horsepower: 190 DIN at 6500 RPM  
Torque: 169 Lb Ft at 4700 RPM  
Compression Ratio: 11.5:1  
Camshaft: "S"

Stage IV is essentially the same as Stage III except that the engine is overbored to 93mm, increasing total displacement to 2200cc's. Again, this is not sold in kit form. Instead the following parts must be used.

Part No.	Qty.	Description
552424-4	1	Special cylinder head with large volume combustion chamber (see page 5 for specs)
552836-9	1	Special turbopressure head gasket for 93mm bore
552451-7	4	93mm forged aluminum Mahle pistons (1969-73 B20 only)
552450-9	4	93mm forged aluminum Mahle pistons (1974-75 B20)
552910-2	1	19 tube oil cooler
552445-9	1	Camshaft "S" (see page 8 for specs)

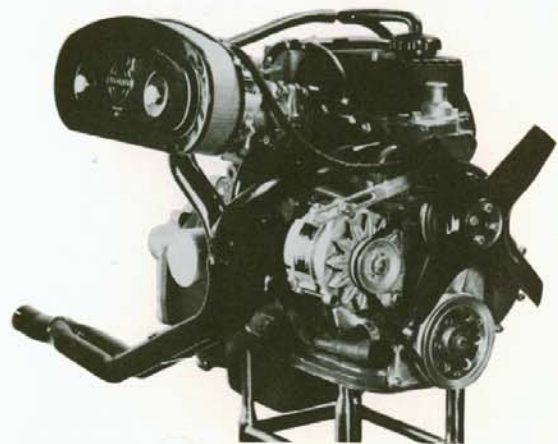
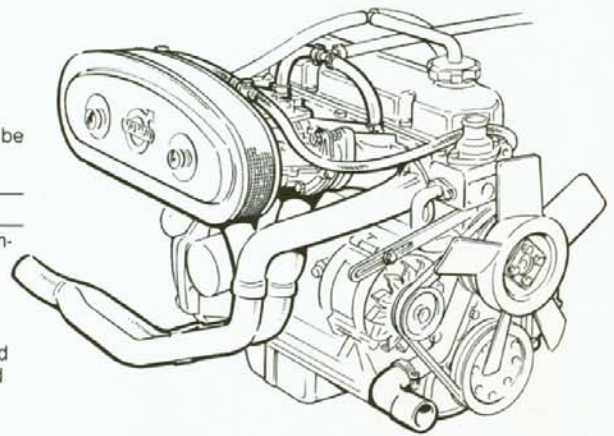



# engine B18/B20

## CYLINDER HEADS

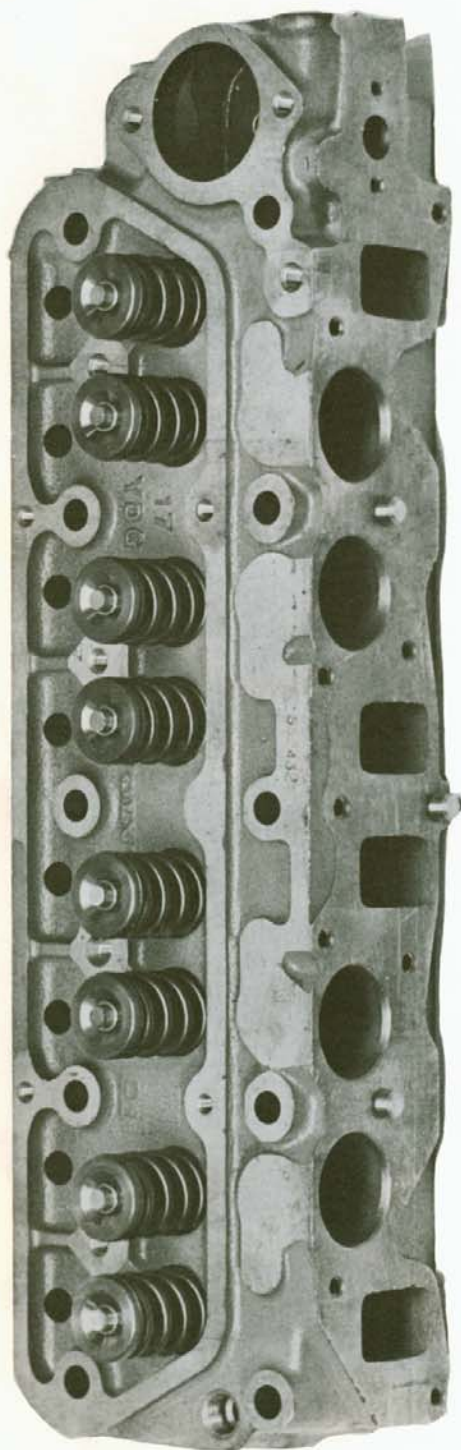

All competition cylinder heads are specially cast with different port contours and combustion chamber design. Manufactured in our own Skovde, Sweden engine foundry for the upmost in materials, quality, and workmanship.

### Stage I

Port and valve sizes same as std. fuel injection head, but both are shaped differently. 44mm intake/35mm exhaust. Compression ratio 10.5:1. Produces 7 to 15 more horsepower, depending on induction system.

Part Number 552441-8

### Stage I "E"

Same casting as Stage I, but with holes drilled for fuel injection nozzels. Boosts power by approximately 15 h.p. DIN over std. B20E used in 1970-71 1800 and 142. Compression ratio 10.5:1.

Part Number 552442-6

### Stage I "F"

Same as Stage I "E" except compression ratio is dropped to 9.0:1 for use on B20F engine (regular or unleaded fuel). Increases power by approximately 12 h.p. DIN over std. B20F used during 1972-75.

Part Number 552444-2

### Stage I Special "E"

Same as Stage I "E" except ports remain standard size for Group I homologation.

Part Number 552425-1

### Stage II

Same as Stage I except valve spring seats are lower for use with "S" or "U" camshaft. Compression ratio 11.0:1.

Part Number 552423-6

### Stage III

Large polished ports and valves (46mm intake/38mm exhaust), fitted with double valve springs and aluminum retainers. Compression ratio 11.0:1.

Part Number 552432-7

### Stage IV

Same as Stage III except larger combustion chamber is used (39cm<sup>3</sup>) for 11.5:1 compression ratio in 2200 cc engine.

Part Number 552424-4

# engine B20

## CYLINDER HEAD PARTS

Part No.	Qty.	Description	Specification
419766-1	4	Intake Valve	Std. 44mm as used in 70-75 fuel injection
419735-6	4	Exhaust valve	Std. 35mm as used in 70-75 fuel injection
552834-4	4	Intake Valve	Std. material and shape but size increased to 45mm
552835-1	4	Exhaust Valve	Std. material and shape but size increased to 38mm
552848-4	4	Racing Intake Valve	44mm, lightened, polished, tuliped, made of stainless steel
552849-2	4	Racing Exhaust Valve	35mm, lightened, polished, tuliped made of stainless steel
552823-7	4	Racing Intake Valve	45mm, lightened, polished, tuliped made of stainless steel
552824-5	4	Racing Exhaust Valve	38mm, lightened, polished, tuliped made of stainless steel
552816-1	4	Stage I Intake Valve	44mm, specially shaped and treated stainless steel
552817-9	4	Stage I Exhaust Valve	35mm, specially shaped and treated stainless steel
552813-8	4	Stage III Intake Valve	46mm, specially shaped and treated stainless steel
552815-3	4	Stage III Exhaust Valve	38mm, specially shaped and treated stainless steel
419652-3	4	Std. valve guide for intake	
419653-1	4	Std. valve guide for exhaust	
552828-6	4	Short, cone shaped valve guide for intake to eliminate flow restriction	
552818-7	4	Short valve guide for exhaust to eliminate flow restriction	
418737-3	8	Std. valve spring	
552436-8	8	Special outer valve spring for double spring application. Used on Stage III & IV cylinder head. Provides extra protection against valve drop from spring overload.	
552437-6	8	Special inner valve spring for double spring application. Double springs should be used for engines operating above 6500 RPM.	
460181-1	8	Std. steel valve retainer for std. spring	
552438-4	8	Extra hard aluminum valve retainer to be used in conjunction with double valve springs. Reduces valve train weight	
419702-6	8	Valve seals, std.	
419643-2	16	Valve keepers, std.	
552832-8	1	Adjusting shim kit for std. springs	
552439-2	1	Adjusting shim kit for double valve springs	
824855-1	1	Special high-compression cylinder head gasket for 89mm bore (std.) 1.2mm thickness	
552836-9	1	Special turbopressure head gasket for bore size up to 93mm (2200cc) 1.3mm thickness	

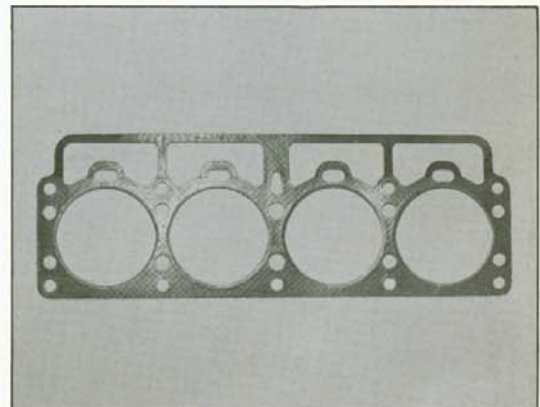
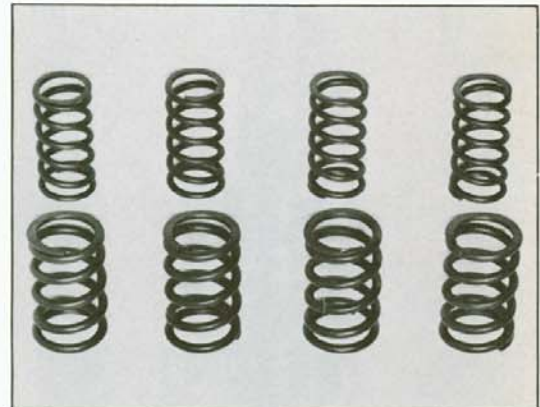
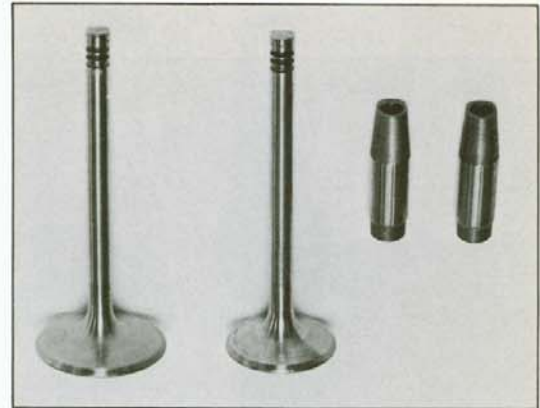



# engine B18/B20

## CAMSHAFTS AND LIFTERS

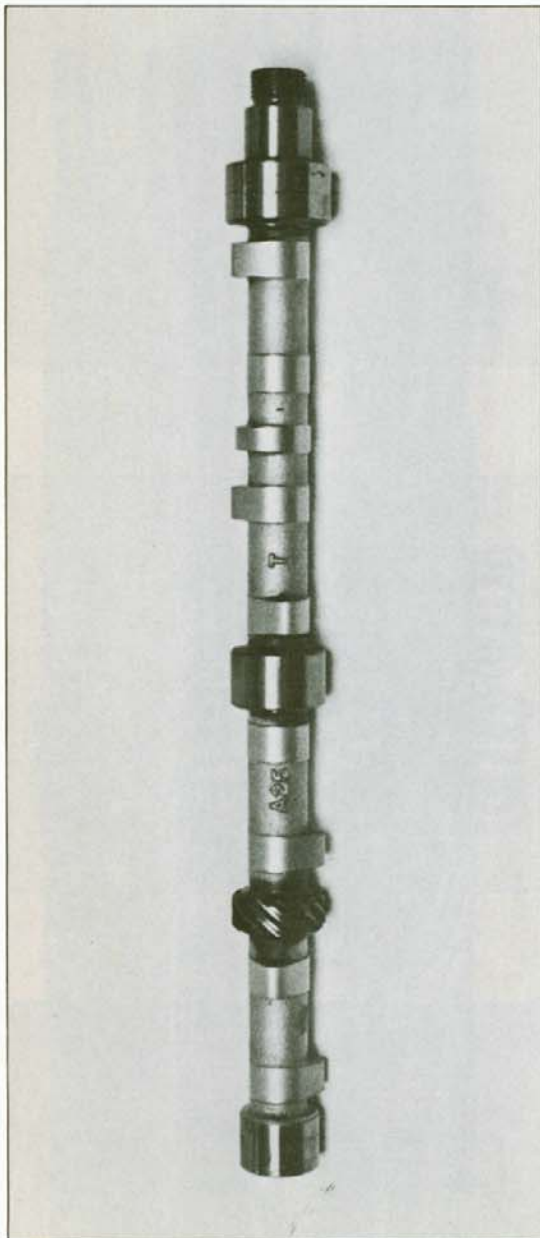

All competition camshafts are original castings from our engine foundry in Skovde, Sweden. They are special hardened with a hard chrome process to avoid premature wear from the extreme temperatures and pressures found in competition.

Each particular camshaft profile has been carefully planned with the aid of Volvo Data and many hours of testing in the engine laboratory and race track. These various profiles are unique to Volvo and are designed for optimum/maximum performance when used in conjunction with other Volvo parts under driving conditions described herein.

### “K” Camshaft

The original camshaft included in the GT Tuning kit. Similar in design to the std. camshaft used in the B20 fuel injection engine, but with a significant improvement in slow speed torque. Ideal for spirited street driving and heavy loads. Works best with twin carburetors (S.U. or Z.S.) standard fuel injection, or Solex downdraft (GT kit). Meets Swedish exhaust standards, but not certified with EPA.

Valve Lift	Inlet Opens Before TDC	Inlet Closes Before BDC	Exhaust Opens Before BDC	Exhaust Closes Before TDC	Valve Setting	Total Duration
.420 in	27°	70°	70°	27°	.016/.018 in	277°

Part Number 552422-8

### “F” Camshaft

The basic camshaft as supplied in the Stage I and Stage II Tuning kits. A compromise design for both highway and competition driving that provides a significant improvement in maximum horsepower with an upward shift of the torque curve. Can be used with all induction systems except electronic fuel injection. Best when matched to rear axle ratios of 4:10 through 4:88. Meets Swedish exhaust emission standards, but not certified with EPA.

Valve Lift	Inlet Opens Before TDC	Inlet Closes Before BDC	Exhaust Opens Before BDC	Exhaust Closes Before TDC	Valve Setting	Total Duration
.440 in	30°	81°	81°	39°	.016/.018 in	300°

Part Number 552460-8

### “R” Camshaft

The best all-around camshaft for short twisty race courses or tight performance rally stages. Excellent torque characteristics at 4500 RPM with maximum power developing at 6200 RPM. Not quite as strong in 5200 to 6200 RPM range as “F”, but much more tractable below 5000 RPM. Best when used with twin Solex carburetors and 4:88 rear axle ratio, but is useable with all induction systems except single Solex or Electronic fuel injection.

Valve Lift	Inlet Opens Before TDC	Inlet Closes Before BDC	Exhaust Opens Before BDC	Exhaust Closes Before TDC	Valve Setting	Total Duration
.460 in	42°	65°	64°	44°	.016/.018 in	287°

Part Number 552430-1



# engine B18/B20

## CAMSHAFTS AND LIFTERS

### "S" Camshaft

Strictly a competition profile designed for fast rally stages and medium length race courses. Torque curve is similar to "R" except that maximum RPM is pushed to 7000 RPM for an increase in 10 h.p. over "R". Should be used with twin Solex carburetors fitted with 40mm venturi. Best when coupled to close-ratio gearbox and 4:88 or 5:38 rear axle.

Valve Lift	Inlet Opens Before TDC	Inlet Closes Before BDC	Exhaust Opens Before BDC	Exhaust Closes Before TDC	Valve Setting	Total Duration
.510 in	49°	71°	71°	49°	.020/.020 in	300°

Part Number 552445-9

### "U" Camshaft

The "Full Race" camshaft intended for long courses that don't require much mid-range torque. Provides a flatter horsepower curve than "S" in the 6000 to 7000 RPM range. Solex carburetors with 43mm venturi, close-ratio gearbox and 4:88 or 5:38 rear axle ratio are recommended. Note: the fuel injected cast iron exhaust manifold (P.N. 460894-9) coupled with a front pipe modified to extend the separate twin pipes another 4 inches is the best extractor system for both the S and U camshafts.

Valve Lift	Inlet Opens Before TDC	Inlet Closes Before BDC	Exhaust Opens Before BDC	Exhaust Closes Before TDC	Valve Setting	Total Duration
.510 in	54°	78°	78°	54°	.020/.020 in	312°

Part Number 552446-7

### Hardened Lifters

Specially hardened and treated lifters to withstand the high temperatures and spring pressures of competition engines. Should be used in conjunction with "K", "F", and "R" camshaft.

Part Number 552466-5

Qty-8

### Lightened Lifters

Same as hardened lifter except that each has been precision cross-drilled to reduce weight by nearly half. A must for engines operating above 6000 RPM with "R", "S", or "U" camshaft.

Part Number 552841-9

Qty-8

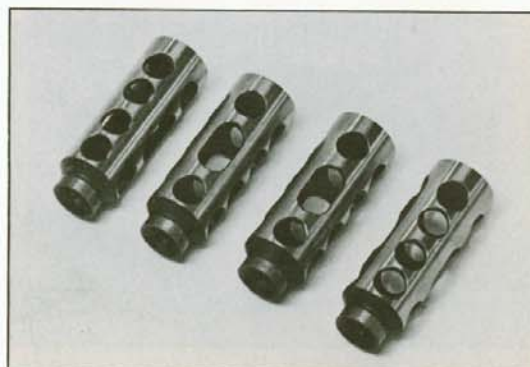
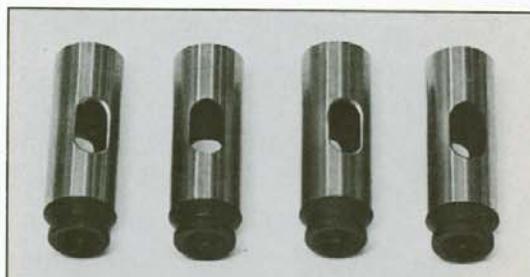
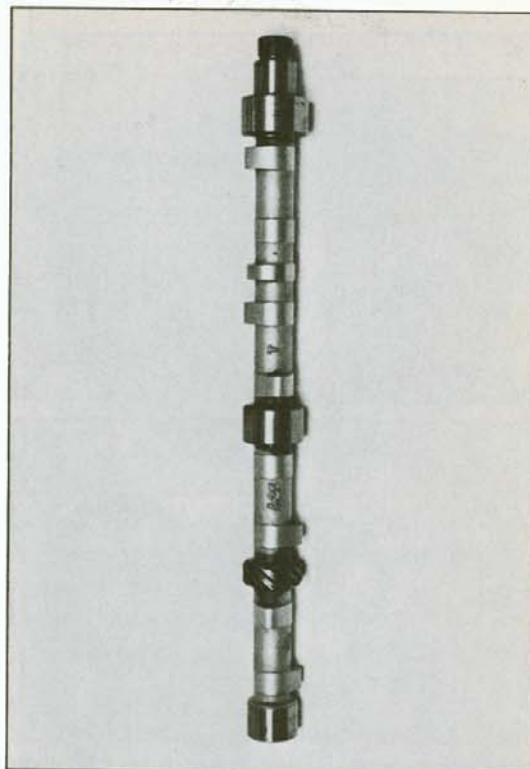

# engine B18/B20

## MISCELLANEOUS ENGINE PARTS

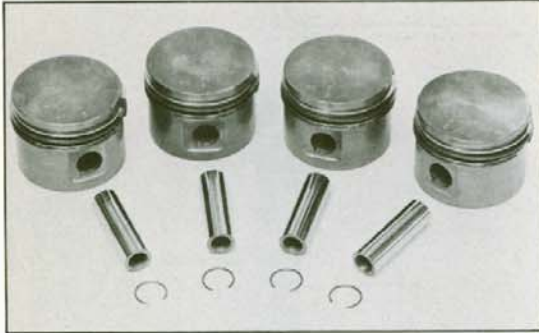

### Pistons

Forged Mahle aluminum racing pistons are recommended for any engine with high compression (10.5:1+) used in competition. Superior materials and forging process avoids breakage and deformation caused from detonation as a result of high combustion chamber pressures and temperatures. Each piston is complete with rings, wrist pins, and retaining clips.

Part No.	Qty.	Description	Specification
552453-3	4	Forged Piston	89mm dia. for 1998cc displacement (B20) 1966-73 B18/B20
552451-7	4	93mm Forged Piston	93mm dia. for 2200cc 1969-73 B20
552450-9	4	93mm Forged Piston	93mm dia. 2200cc but uses large wrist pin for use in 74-75 B20 and all B21

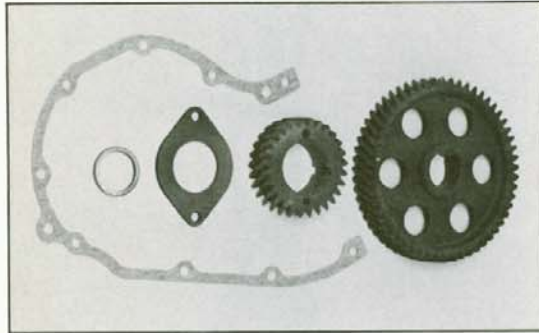

### Timing Gears

Hardened steel timing gears to replace the plastic fiber cam gear on production engines. Although generally a little noisier than std. gears, they are highly recommended for engines consistently over 6000 RPM. Kit includes both cam and crankshaft gears along with bolts, washers, and gasket.

Part No.	Description	Model Application
875375-8	Steel Timing Gear Set	B18/B20

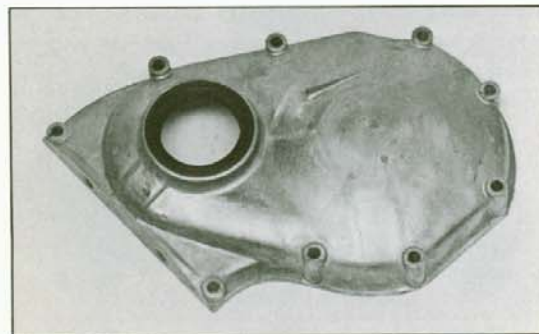

### Heavy Duty Timing Gear Cover

Complete cover with heavy duty neoprene rubber seal replaces std. production felt seal. Recommended to control additional oil seepage from high temperatures and crankcase pressure.

Part No.	Description	Model Application
418693-8	Timing Gear Cover	B18/B20



### Heavy Duty Rear Crank Seal

New housing and neoprene rubber seal replace std. felt seal used on production B18/B20 engines up to 1973. Eliminates oil from seeping onto clutch lining during high crankcase pressures and temperature.

Part No.	Qty.	Description	Model Application
462729-5	1	Seal Housing	1962-73 B18/B20
430118-0	1	Rubber Seal	1962-73 B18/B20
418257-2	1	Gasket	1962-73 B18/B20



## MISCELLANEOUS ENGINE PARTS

### Lightened Flywheel

Lightened steel flywheel for faster throttle response and quicker, less strenuous gear shifting. Recommended for both street and competition. Saves 6 lbs. over std. flywheel.

Part No.	Description	Model Application
419392-6	Lightened Flywheel 6 bolts	1962-73 B18/B20 with 6 bolt crankshaft
552833-6	Lightened Flywheel 8 bolts	1974-75 B20, all B21 with 8 bolt crankshaft

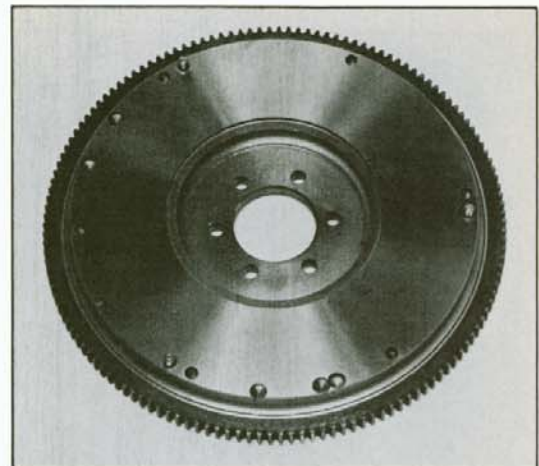

### Special Oil Pan

Standard oil pan modified with windage type plate to prevent oil from frothing with crankshaft. Also features reinforced oil drain hole.

Part No.	Description	Model Application
552847-6	Oil Pan	All B18/B20

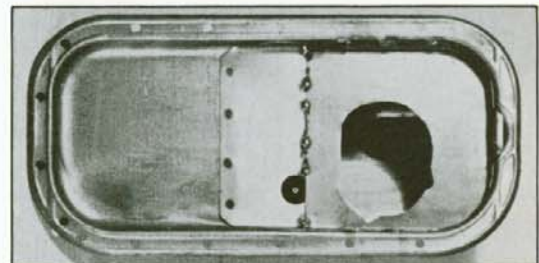

### Oil Cooler

Radiator type oil coolers to prevent overheating of oil from heavy engine loading. A must for any type of competition, but highly recommended for std. engines used under heavy load or operated in high ambient temperatures. Kit includes heat exchanger (radiator), hoses, clamps, aluminum adaptor plate and installation instructions.

Part No.	Description	Model Application
552900-3	13 Tube Oil Cooler	Recommended for normal and heavy duty use.
552910-2	19 Tube Oil Cooler	Recommended for rally and racing.

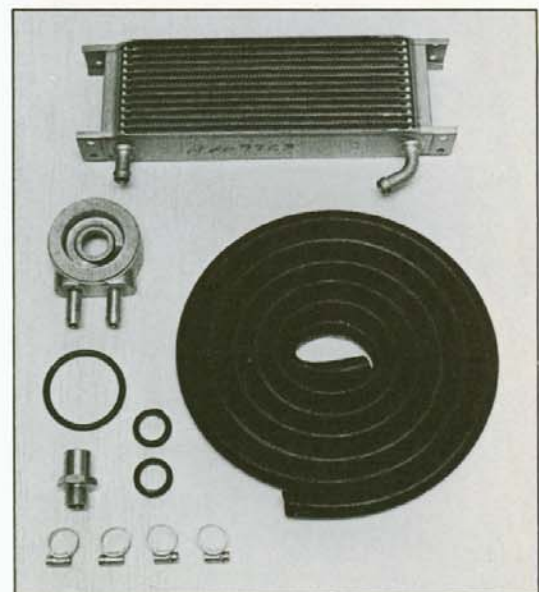

# VOLVO fuel systems

## SOLEX SIDE-DRAFT CARBURETOR KIT

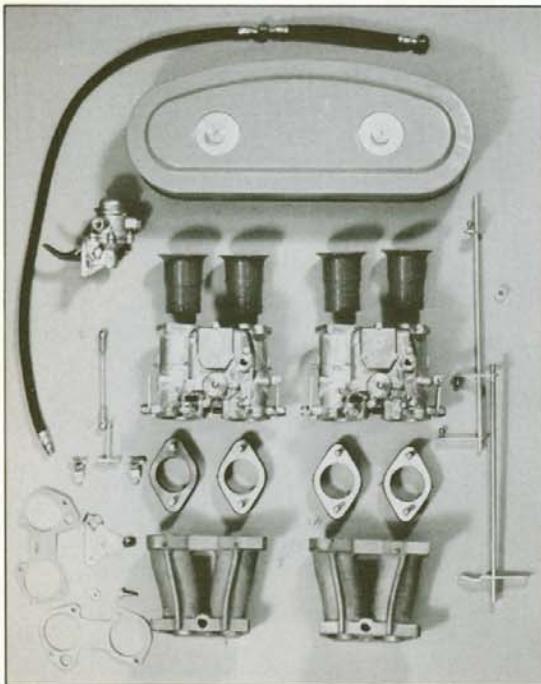
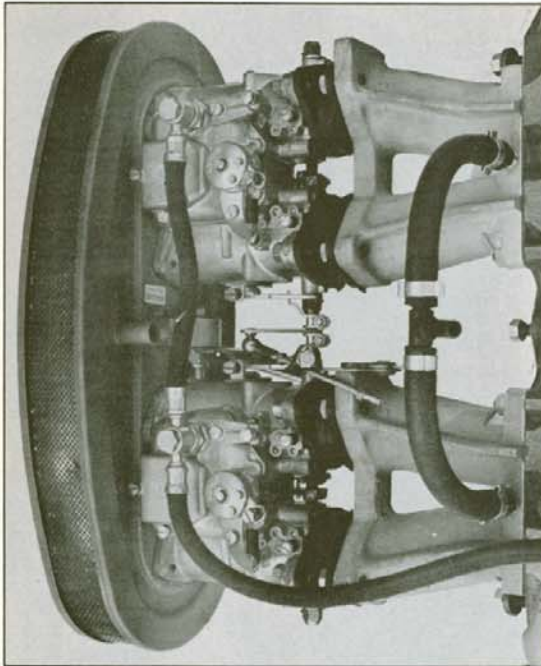

The most effective system for extracting the maximum amount of power from the Volvo engine. A complete induction system that includes twin 45mm ADDHE (aluminum) dual choke side-draft Sorex carburetors, individual aluminum intake manifolds, special rubber insulator spacers, fuel hose, fuel pump, all throttle linkage, air filter and housing, velocity stacks, engine brace and all necessary nuts, bolts, studs, washers and gaskets for simple installation.

The side-draft Sorex induction system is designed to replace the standard induction system used on the production engine, but further engine improvements are recommended. Modifications to the cylinder head, camshaft and exhaust system should be made if the full potential is to be realized. While the short intake manifold and large venturi area are highly desirable for maximum power at full throttle, drivability at low speeds is diminished.

The new generation 45mm ADDHE Sorex carburetor replaces the earlier 45mm DDH (part number 552600-9) type that established itself to be such a reliable unit. The new type is further improved by the use of light weight aluminum alloy, throttle spindles mounted in ball bearings to eliminate wear, quick-change main and air jets located on top, and newly designed throttle linkage for easy and lasting synchronization.

The complete kit has been designed for the 140 series but all components are available separately for those who wish to adapt the system to the 120, 1800, or 544 models. Neither the throttle nor the air filter of the 140 kit will fit these earlier models.

A listing of the major components of the Sorex carburetor kit is as follows:

Part No.	Qty.	Description
552615-7	1	Complete carburetor kit
419764-6	1	Combination intake/exhaust manifold gasket
419883-4	1	Front intake manifold
419884-2	1	Rear intake manifold
819769-1	8	Manifold to carburetor gasket
824643-1	4	Special Pirelli rubber flange (45mm I.D.) to isolate carburetors from heat and vibration
552630-6	1	Front 45mm Sorex (ADDHE) carburetor
552629-8	1	Rear 45mm Sorex (ADDHE) carburetor
824708-2	4	Velocity stacks
684036-7	1	Complete air filter and housing
552620-7	1	Air filter insert
831092-2	1	High capacity fuel pump
684899-8	1	Throttle linkage, upper 67-72
552431-9	1	Throttle linkage, upper 73-74
1206551-2	1	Throttle bracket
460047-4	1	Air cleaner support



## JET COMBINATION FOR SOLEX ADDHE

### Carburetor

Part Numbers: 552629-8 and 552630-6

#### Stage I & II

Part No.	Qty.	Description	Application
1155040-7	4	36mm choke tube	Std. in carburetor. Good for normal driving with Stage I & II kits.
1155124-9	4	190 main jet	
1155127-2	4	220 air jet	

#### Stage III & IV

Part No.	Qty.	Description	Application
552609-0	4	40mm choke tube	
1155252-8	4	195 main jet	
1155253-6	4	200 air jet	
1155255-1	1	Complete jet set (includes all the above)	Recommended for Stage III & IV

## JET COMBINATION FOR SOLEX DDH

### Carburetor

Part Number: 552600-9

#### Stage I & II

Part No.	Qty.	Description	Application
1155040-7	4	36mm choke tube	Std. in Solex DDH. Good for normal driving.
1155024-1	4	185 main jet	
1155038-1	4	175 emulsion tube	

#### Stage II & III

Part No.	Qty.	Description	Application
552609-0	4	40mm choke tube	
1155104-1	4	150 main jet	
1155105-8	4	120 emulsion tube	
1155115-7	1	Complete jet set (includes all the above)	Recommended for Stage II & III in rally

#### Stage IV (2200 cc)

Part No.	Qty.	Description	Application
1155121-5	4	43mm choke tube	
1155119-9	4	155 main jet	
1155105-8	4	120 emulsion tube	
1155120-7	1	Complete jet set (includes all the above)	Recommended for Stage III & IV racing

## MISCELLANEOUS SOLEX PARTS For DDH Carburetor

Part No.	Qty.	Description	Application
552604-1	2	Idle jet, 57.5	Std. in Solex DDH
552606-6	2	Idle jet, 62.5	For colder climates
552601-7	1	Gasket kit, both carburetors	
552602-5	1	Complete rebuilding kit for both carburetors. Includes all gaskets, jets, floats and diaphragms for both carburetors.	

Note: A complete listing of all Solex carburetor parts can be found in the Master voivo R Sport Competition Parts catalog at your authorized Volvo dealer.

## fuel systems

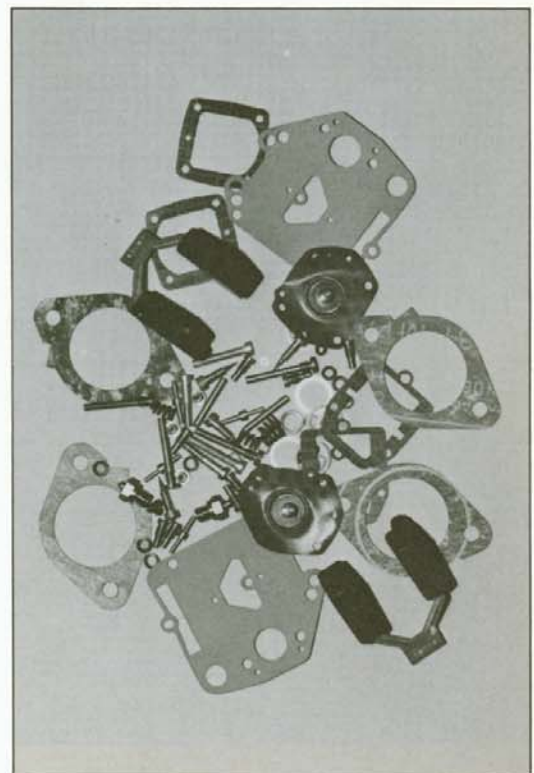
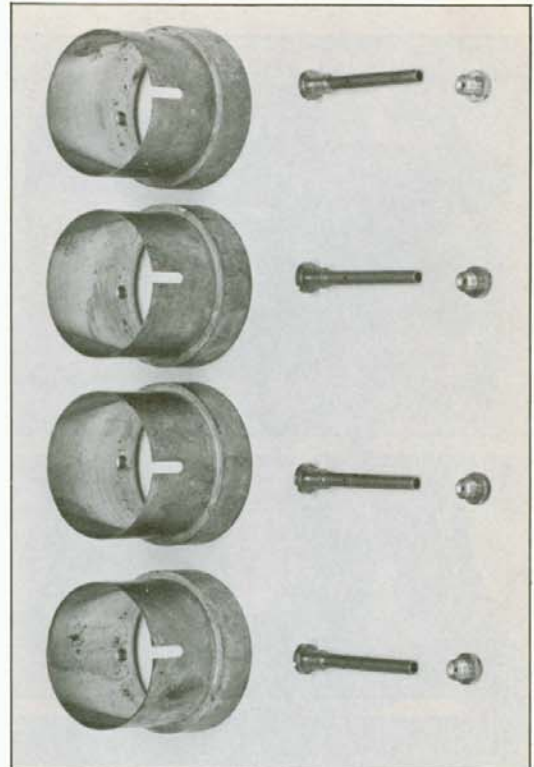

# fuel systems

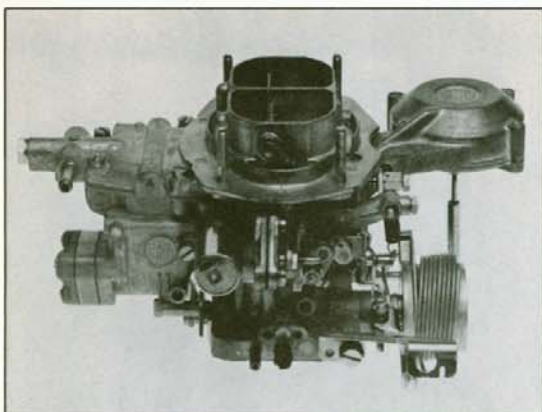

## SOLEX DOWN-DRAFT CARBURETOR

The Solex 40mm EIES two barrel down-draft carburetor has been specifically selected and jetted for use in our complete GT Tuning Kit (part number 552550-6).

However, for those who wish to experiment on their own, each part is available separately. A listing of the major components is as follows:

Part No.	Qty.	Description
552554-8	1	Complete Solex 40 EIES carburetor
552555-8	1	Aluminum intake manifold with temperature stabilized by coolant
552552-2	1	Complete air filter and housing
552570-4	1	Air filter insert

Note: For a complete listing of all parts used in the GT Kit, consult the Master Volvo R Sport Competition Parts catalog at your authorized Volvo dealer.

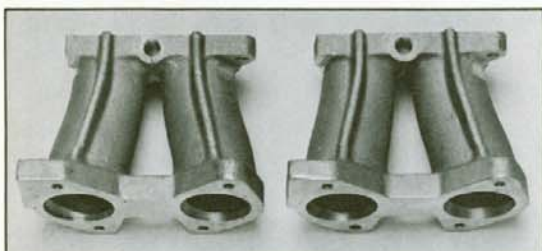

## INTAKE MANIFOLDS

Specially cast aluminum alloy individual intake manifolds for Solex 45mm side-draft carburetors or other similar side-draft carburetors. Designed for maximum strength and efficiency with the B20 cylinder head.

Part No.	Description
419883-4	Front intake manifold
419884-2	Rear intake manifold

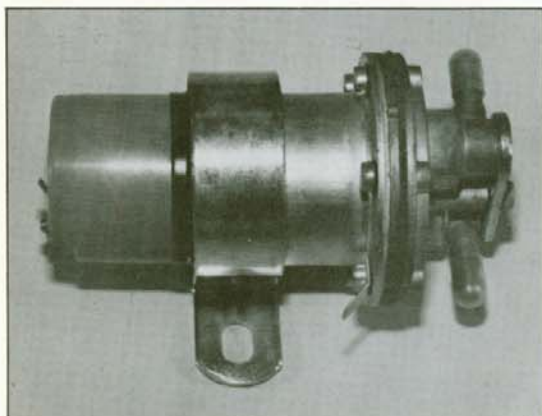

## Stage III & IV MANIFOLDS

Same castings as above, but carefully ground and polished inner passages are perfectly matched to ports for maximum, undisturbed flow.

Part No.	Description
552613-2	Front intake manifold
552614-0	Rear intake manifold

## ELECTRIC FUEL PUMP

Ultra high capacity electric fuel pump delivers 35 gallons an hour at 4.0 p.s.i. Eliminates risk of vapor lock in high temperatures when located near the tank. Stage IV engines used in racing should use two pumps in parallel. Part Number: 552004-4

## HIGH CAPACITY FUEL PUMP

High capacity mechanical fuel pump as used in the GT and Stage I and II Tuning Kits. Part Number: 831092-2

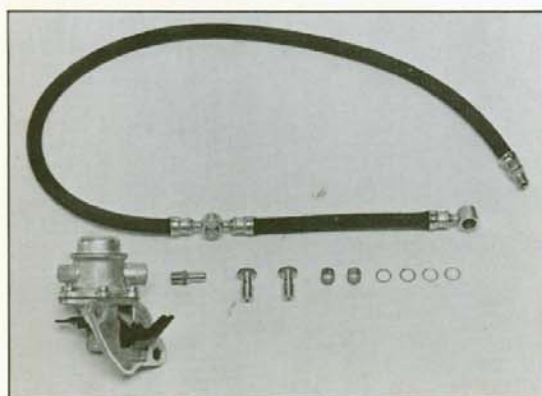

## FUEL HOSE

Specially fabricated fuel hose designed for use with twin Solex carburetors and mechanical fuel pump. Part Number: 825856-8

Note: A complete listing of all fuel system components can be found in the Master Volvo R Sport Competition Parts catalog at your authorized Volvo dealer.



# VOLVO exhaust systems

## RALLY EXHAUST SYSTEMS

Complete exhaust systems utilizing larger 2 1/4" pipe and free-flow mufflers for minimum back-pressure.

Kit increases power by 5 to 9 h.p. DIN, depending on model, without an appreciable increase in noise level.

Heavy duty construction allows for trouble-free operation in competition rally and racing.

All kits fit in same exact location as the standard system, and come complete with gaskets, clamps, mounting brackets and instructions.

Note: Individual pipes, mufflers and brackets are listed in the Master Volvo R Sport Competition Parts catalog at your authorized Volvo dealer.

Part No.	Application
552299-0	120 series up to and including 1966. Does not fit the 220 wagon.
552300-6	120 series 1967-69. Does not fit the 220 wagon.
552298-2	All 140 series up to and including 1973
552289-1	1974 140 series and 1975 240 B20F engine without catalytic converter
552296-2	1976-1979 240 series with B-21 engine. Can not be used with catalytic converter. Not legal for road use in U.S.

Note: Rally Exhaust Systems have not been certified with EPA or various state agencies. Therefore, we can only recommend their use in off-road applications.

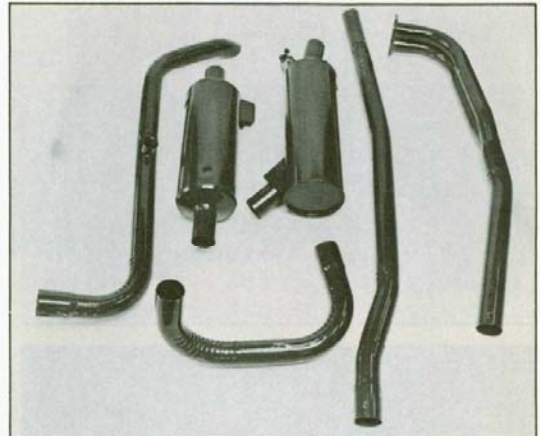

## EXHAUST MANIFOLDS

Tuned steel tubular header designed for optimum torque in the low and mid RPM range. Ideal for street and rally use with K, F, and R cams. Fits all models with B18/B20 engine, but the front pipes of both the standard and rally exhaust systems must be modified to accept the 2" slip-joint type collector.

Part Number: 419381-9

Cast iron production exhaust manifold as used on all fuel injected models, is recommended for Stage III and IV engines using "S" or "U" camshaft in high speed rally and racing. For optimum power at 7000 RPM, it is recommended that the separated twin pipe section of both the standard and rally front pipe be extended another 4 inches before joining into a single pipe.

Part Number: 460894-9

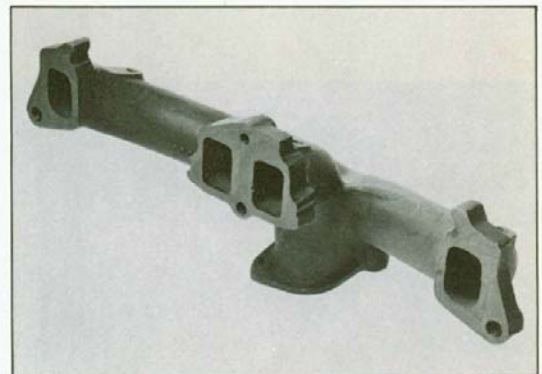

# VOLVO electrical equipment

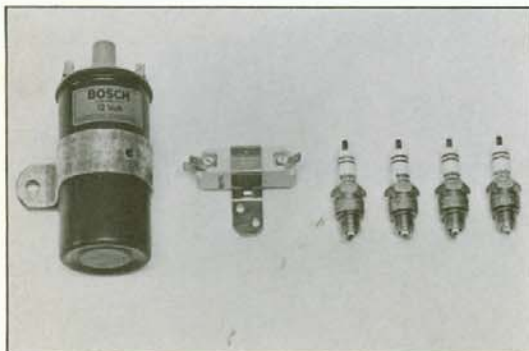
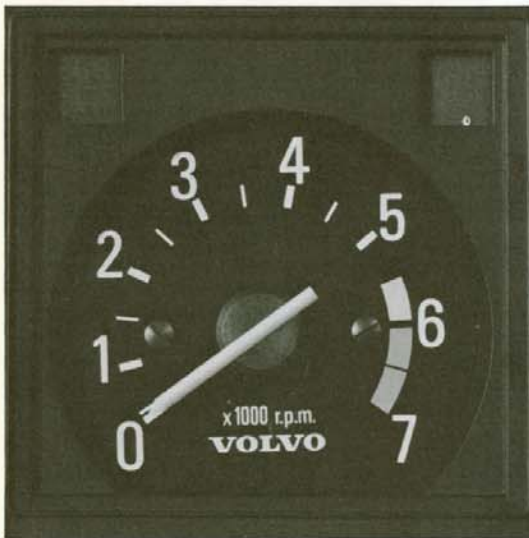
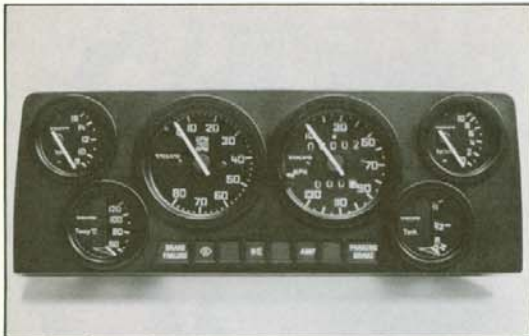

## GT Instrument Panel

Tachometer, speedometer, oil pressure gauge, voltmeter, odometer/tripmeter, water temperature and fuel level gauges are all clustered together in one panel located directly in front of the driver.

Designed with highly visible yellow lettering on matte black finish and reflection free anti-glare glass. Mounts in same manner as standard instrument panel for quick and easy installation.

Part No.	Application	Part No.	Application
283150-1†	1977-79 242/244	283069-3*	1976 262/264
283148-5†	1977-79 245	283142-8*	1976 265
283149-3*	1977-79 265	283072-7	1973-75 164
283067-7†	1975-76 242/244	283151-9*	1977-79 262/264
283065-1†	1975-76 245		

GT Instrument panel with km/h (kilometer) speedometer for use in Canada only.

283144-4†	1977-79 240
283147-7*	1978-79 260

† Requires oil plug 809109-2

\* Requires oil plug 464592-5 and 809109-2

Note: Separate components for the above GT Instrument Panels and older (1967-72) Rally Instruments Panels, (Part Number 552703-1 and 552723-9) can be found at your authorized Volvo dealer.

## Tachometers

Designed for simple installation in the standard instrument panel.

Fully transistorized for instant response and accuracy.

Part No.	Application
283546-0	1975-79 240
283547-8	1975-79 260
282772-3	1973-74 140
282773-1	1973-75 164

## Ignition Coil

High energy ignition coil for use with any engine using cold spark plugs and turning high RPM's.

Part Number: 826490-5 and accompanying resistor, part number 241612-1

## Spark Plugs

Part No.	Qty.	Description	Application
75053-9	4	Bosch W200 T35	Std. production for all B18 & B20B & F
273524-9	1	Kit of 4 Bosch W200 T35	
238624-1	4	Bosch W240 T1	Stage I & II engines for normal driving
75055-4	4	Bosch 225T1	Used in B20 GT Kit. Recommended for B20E & tuned engines up to 130 h.p.
273536-3	1	Kit of 4 Bosch 225T1	
552029-1	4	Bosch W280S1S "Sport"	Stage II & III for normal and rally driving
552499-6	4	Bosch W310S1S "Sport"	Stage III & IV for fast rally and racing



## electrical equipment

### Halogen Fog Light Kit

Quartz-iodine fog lights mount under the front bumper of all 140/160, 1800 and 240/260 models.

Low mounting point and widespread pattern with sharp cut-off at top insures superior visibility without reflective glare.

Complete with 55W H3 bulbs, wiring harness, switch, relay, adjustable mounting brackets, and installation instructions.

Part Number: 284005-6

1128507-9 (Canada only) Not in kit form. Each lamp sold separately.

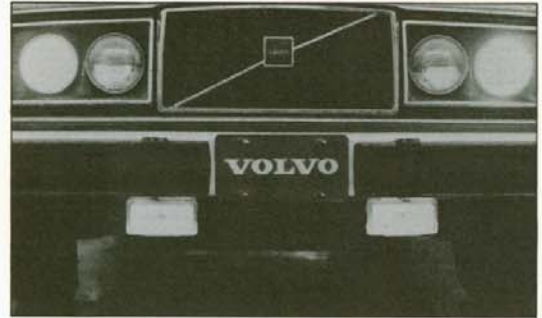

### Grille Fog Light Kit

Auxillary driving lamps neatly recessed into a special grille for that GT appearance, while providing extra protection for the lamps.

Kit comes complete with new grille and emblem, clear lens fog lamps, bulbs, wiring harness, relay, dash mounted rocker switch, adjustable mounting brackets, and detailed installation instructions.

Part Number: 1128683-8 1978-79 242 only  
283665-8 1975-77 242, 244, 245  
283666-1 1975-77 242, 244, 245  
(Spotlight, Canada only)  
283803-5 1975-77 242, 244, 245  
(Amber Fog, Canada only)



### Rally Driving Light

The world renowned "Calle Orrenius" competition driving light by Bosch. The 180mm lead crystal lens coupled with a 100W H3 quartz-iodine bulb projects 240,000 candlepower for a reflective range of 1.4 miles. The choice of rally champions all over the world.

Designed to mount on bumpers of all 140, 160 and 1800 models.

Each lamp is equipped with threaded mounting stud and protective plastic cover. Does not include H3 bulb.

Part Number: 552028-3

Note: Rally Driving Light is recommended for off-road use only.



# electrical equipment

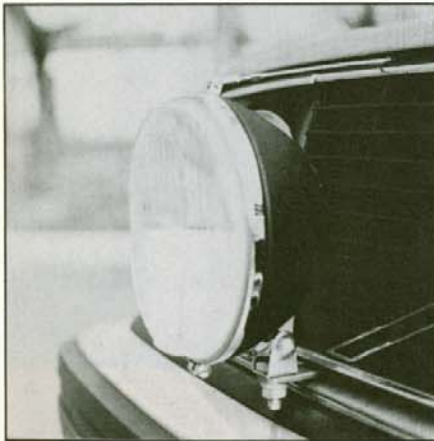

## Auxiliary Driving Lights (Canada Only)

Halogen Lamps are 160mm (6") in diameter and are available in a long range (500 meters) pencil-beam spot lamp or a wide-spread clear Fog Light. Mounts to bumper on earlier models and special brackets (see below) on 240/260 model.

Does not include H-3 bulb.

Part Number: 1128268-8 Fog Light  
1128269-6 Spot Light

## Headlamp Inserts

Halogen H-4 Headlamps are available for all models in Canada only. See your authorized Canadian Volvo Dealer for a complete listing.

## Adjustable Light Bracket

An 8" fully threaded rod that secures the top of the Rally Driving Light to the front body support of the car.

Eliminates light vibration for improved effectiveness and allows for extremely fine adjustments.

Part Number: 552031-7

## Mounting Brackets

Special mounting brackets with adjusting stays have been designed to suspend driving lights over the retractable bumper of 240/260 series.

Each Kit includes one mounting bracket and one adjusting stay.

Part Number: 1128272-0

Special brackets are available separately to mount Fog Lights underneath the bumper to avoid damage (included in Kit 284005-6).

Each Kit includes two mounting brackets with bolts.

Part Number: 75190-9

## Fog Lamp Switch

Dash mounted switch allows Fog or Driving Lights to operate independent of headlamps. Available in green rocker-switch to match other switches on '73 through '79 models, or black toggle switch for '62 through '72 models.

Part Number: 1210131-7 1973-79 140/160/240/260  
75179-2 1962-72 ALL MODELS

## Quartz-Iodine Bulbs

Halogen gas filled bulbs provide maximum filament brightness in a small, durable quartz envelope.

Popular H3 design fits quickly and easily into all Volvo Fog and Driving Lights.

Part Number: 277751-4 55W bulb for fog lights.  
552030-9 100W bulb for rally driving lights.



## Auxiliary Light Wiring Harness

A complete wiring harness for two Rally Driving Lights or other bumper mounted auxiliary lamps.

Includes relay, terminals, connectors, and installation instructions.

Part Number: 283330-9

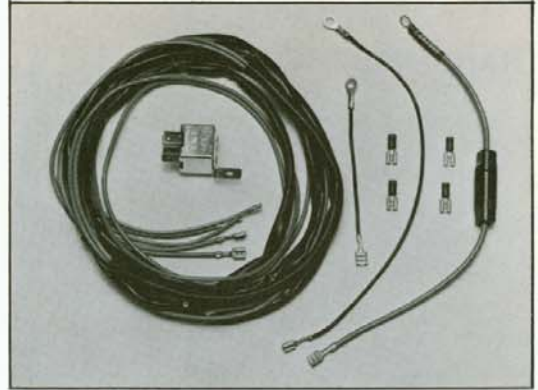

## Map Reading Light

The flexible goose neck lamp is the most popular choice for rally navigators all over the world.

Features push-button switch, chrome plated shaft and an adjustable bulb shield to provide more or less localized light. Fits all models.

Part Number: 283651-8

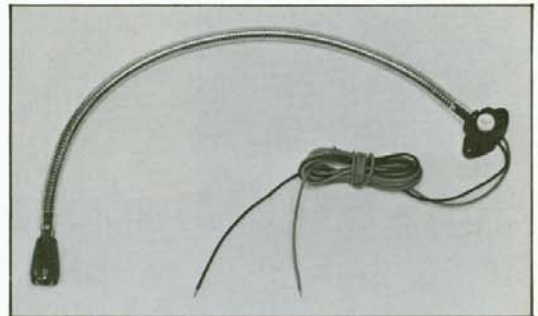

## Interval Wiper Switch

An easy to install plug-in unit that allows variable control of the time lapse between wiper sweeps.

Conveniently located on the dash, the control knob regulates sweep intervals from normal speed (1 sweep per second) to 1 sweep every half minute, and anywhere in between.

Keeps your hands on the wheel and your mind on the road during those wet misty conditions.

Part No.	Application
282880-4	1973-77 140/164/240/260

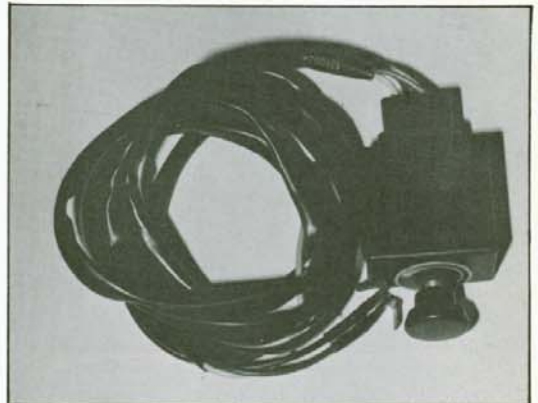

## Large Alternator Pulley

Continuous engine operation between 6000-7000 RPM can over-rev the alternator, causing overheating and premature wear. Larger 86mm pulley reduces alternator RPM by 20%.

Part Number: 552884-9



# VOLVO power train

## TRANSMISSION

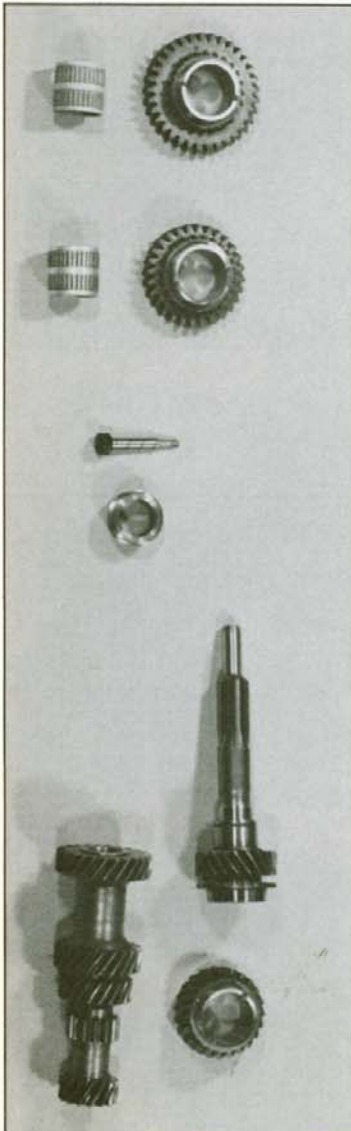
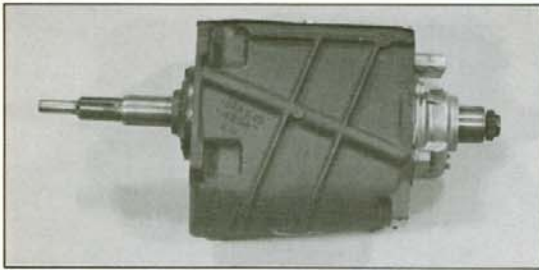

Production standard gearboxes used on all 4 cylinder engines from 1960 through 1975 were designated either M40 for 4 speeds without overdrive, or M41 for 4 speeds with overdrive.

Most M41 gearboxes use needle bearings in the gears located on the long mainshaft that join to the overdrive. The M40 generally used bronze bushings for the gears, but there are exceptions with both gearboxes.

The production gear ratios are the same for both the M40 and M41 gearboxes (except the final fifth speed of overdrive). These ratios were designed for efficient performance and economy with standard production engines and camshafts.

When improving the performance of an engine, a camshaft of higher output is generally selected. Unfortunately, as camshafts become more powerful, the power band (or optimum operating RPM) becomes narrower. To keep the engine operating in this limited RPM range, close-ratio gears have been designed to fit both the M40 and M41 gearbox.

To reduce friction, improve shifting, and provide further dependability, the extra strong close-ratio gears are designed for use with needle bearings instead of the bronze bushings.

Therefore, a gearbox with bronze bushings must first be converted over to a needle bearing type before close-ratio gears can be installed. To convert to needle bearings and close-ratio, refer to the parts listed in Tables B and C.

If the gearbox already has needle bearings, then only the parts listed in Table C need be used.

**Table A: Close-Ratio Versus Standard Ratio**

	RATIO						
	1st	2nd	3rd	4th	5th-O.D.		
Close-ratio M40/M41	2.62:1	1.67:1	1.24:1	1:1	Early Type D	0.756:1	
Standard M40/M41 up to 1973	3.13:1	1.99:1	1.36:1	1:1	Late Type J	0.797:1	
Standard M40/M41 1973-1975	3.41:1	1.99:1	1.36:1	1:1	Early Type D	0.756:1	
					Late Type J	0.797:1	

**Table B: To convert a non-needle-bearing M40 gearbox to a needle-bearing type.**

Qty.	Part No.	Description	Note
1	380217-0	1st speed gear	Production part
1	380218-8	2nd speed gear	Production part
2	181330-2	Needle bearing	Production part
1	181331-0	Needle bearing	Production part

**Table C: To convert a needle-bearing type M40 gearbox to a close-ratio gearbox.**

TYPE	GEAR CLUSTER	PART NO.		
		1st speed gear	3rd speed gear	INPUT SHAFT
M40 model years 67-70	380422-6		380423-4	380382-2
M40 model years 71-72	380824-3		380423-4	380382-2
M40 model years 73-75	380824-3	380217-0	380423-4	380382-2



### HEAVY DUTY CLUTCH

Designed for hard street driving, trailer towing, and competition use with engines up to 165 DIN h.p. 20% higher clamping force with very little increase in pedal pressure.

Part No.	Description
418930-4	Pressure Plate
418871-0	Clutch Disc
380569-4	Release Bearing

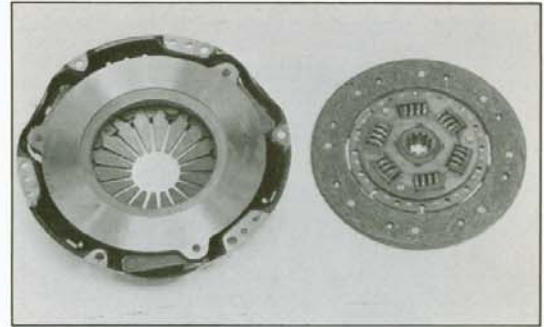

### COMPETITION CLUTCH

Designed for race and rally driving where maximum pressure and durability are required. 80% increase in clamping force.

Part No.	Description
552145-5	Pressure Plate
552146-3	Clutch Disc
672122-9	Release Bearing

### HEAVY DUTY DRIVE SHAFT SUPPORT AND CROSSMEMBER

Extra hard rubber support for center drive shaft bearing insures minimum flex under hard acceleration and off-road use. Extra strong steel collar protects center support in rally and off-road use.

Reinforced and boxed rear crossmember eliminates bending and deformation caused from rally and off-road use. Fits M40 gearbox without overdrive only.

Part No.	Description	Application
552154-7	Rubber Support	140 with B20B up to chassis #112399
552155-4	Rubber Support	140 with B20B&E&F from chassis #112400. All 164
552158-8	Extra Strong Support Collar	1967-74 140 series. All 164
552156-2	Extra Strong Rear Crossmember	1967-74 140 with M40 gearbox

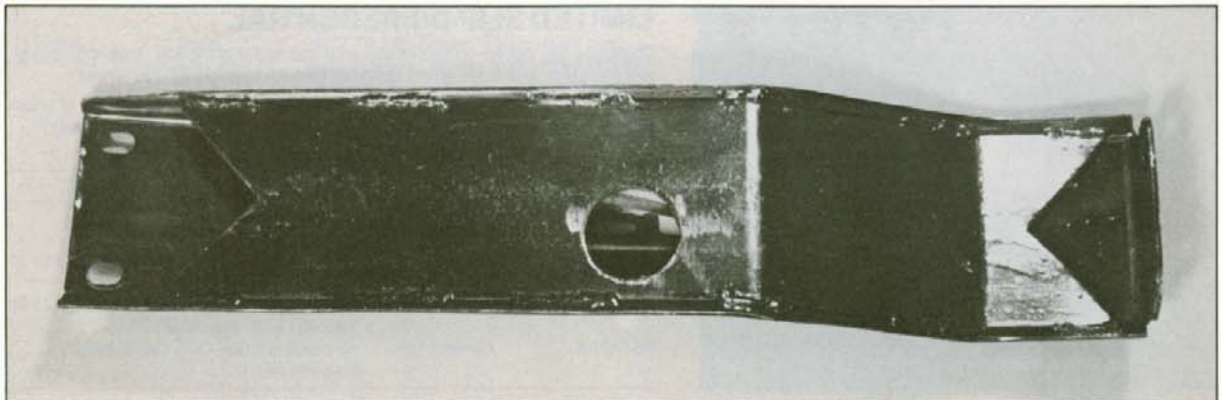

# power train

## REAR AXLE RATIOS

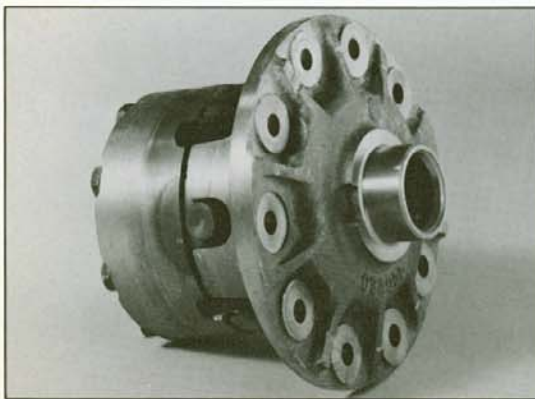
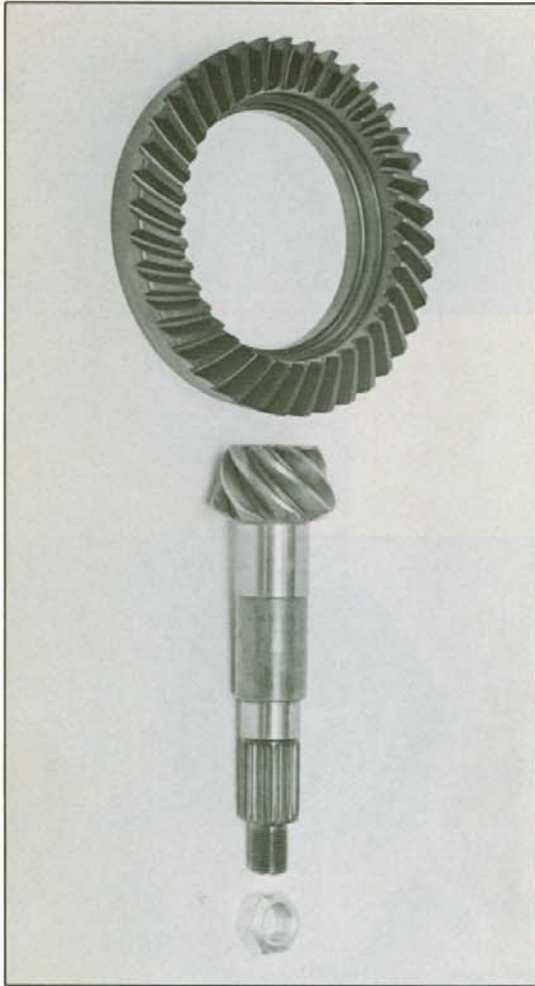

Perhaps the most significant factor in improving acceleration is changing the standard rear axle ratio to that of one numerically higher. The higher the number, the greater the acceleration but, of course, at the expense of maximum top speed. In track racing, for instance, the proper selection is very important, as top speed is a major consideration.

When selecting an alternate rear axle ratio for street use, engine RPM at highway speeds is important, as this has a definite effect on fuel economy, noise level, and to a lesser degree, engine wear. General recommendations are as follows:

### Track Racing

Since course characteristics vary widely, the ratio is generally dependent upon the maximum speed in the longest straight. Normally a 4.88:1 or 4.56:1 are used.

### Rally

Since speeds are generally slower and the terrain more varied, a 5.38:1 is usually best, especially with overdrive.

### Street

Most 4 cylinder models after 1969 used a standard 4.10:1 or 4.30:1 rear axle ratio. Therefore, either a 4.56:1 or 4.88:1 can be used. The latter preferably with overdrive.

Part No.	Description	Specification
552144-8	5.38:1 axle gears	1967-79 M30 rear axle 13.5 MPH at 1000 RPM
500984-0	4.88:1 axle gears	1962-68 M27 rear axle 14.9 MPH at 1000 RPM
525880-1	4.88:1 axle gears	1967-79 M30 rear axle 14.9 MPH at 1000 RPM
273127-1	4.56:1 axle gears	1967-79 M30 rear axle 16.9 MPH at 1000 RPM
380789-8	Output shaft gear	Reduction gear for M40/M41 to give correct speedometer reading with 4.88:1 ratio
380305-3	Speedo gear	Small plastic gear used in conjunction with above gear.

## LIMITED SLIP DIFFERENTIAL

Transfers the power to the wheel with the highest friction, thus improving acceleration in any situation causing lose of traction to one wheel.

A must for rally and racing, but also highly recommended for use in snow and off-road. Also eliminates spinning of inside rear wheel during hard cornering, especially if large rear anti-sway bar is installed.

Part No.	Qty.	Description	Application
279951-8	1	Limited Slip Differential	All models from 1970 (M30 axle)
384509-6	2	Spacer Sleeve	Used in conjunction with 279951-8 to fit 1966-69 M30 rear axle
942654-5	1	Tensioner Pin	Used in conjunction with 279951-8 to fit 1966-69 M30 rear axle
384727-4		Limited Slip	All models from 1970 (M30 axle) (Canada only)



## HANDLING KITS

Suspension tuning may be the most popular area of car preparation but quite often it is the least understood.

Volvo has taken the guess work out of this "black art" by designing suspension kits that offer outstanding road holding ability without totally sacrificing ride comfort and predictable (safe) behavior.

Each handling kit includes special front and rear shocks and larger anti-sway bar(s) to improve overall stability, reduce tire roll over (and wear) during hard cornering, add a more neutral steering characteristic, greatly reduce body roll during cornering, and make the car more responsive to driver input.

Suspension handling kits are designed for those who enjoy spirited driving on winding back roads or just desire a more responsive behavior from their car. Experienced racers and rallyists may want to choose suspension components individually to better suit various driving conditions and preferences.

Part No.	Description	Application
552119-0	120/1800 Series Handling Kit	1962-68 120 Series 1962-73 1800 Series (without air conditioner crankshaft pulley) Special gas pressure shocks and 24mm front anti-sway bar reduces body roll and improves stability.
552179-4	140 Series Handling Kit	1976-74 140 Excellent for both road and rally use. Special gas pressure shock absorbers and larger 20mm front anti-sway bar can be used with either std. springs or progressive rate front spring, P.N. 552105-9.
552095-2	240 Series Handling Kit	1975-76 240 Special gas pressure shocks and 21mm front, 25mm rear anti-sway bars change handling characteristics to a more neutral attitude. Body roll and sway greatly reduce without loss of ride comfort.
552483-0	260 Series Handling Kit	1977-79 260 Special gas pressure shocks and 21mm front, 23mm rear anti-sway bars, and 35% firmer front springs, result in the ultimate 260 series handling package. Significant reduction in body roll with little loss of ride comfort.
1128795-0	GT Road Holding Kit	1977-79 240 Series. 21mm front anti-sway bar and 23mm rear, coupled with 35% firmer front springs. Standard in 1979 242 GT. Gas shock kit, part number 552093-7, is recommended along with this kit.

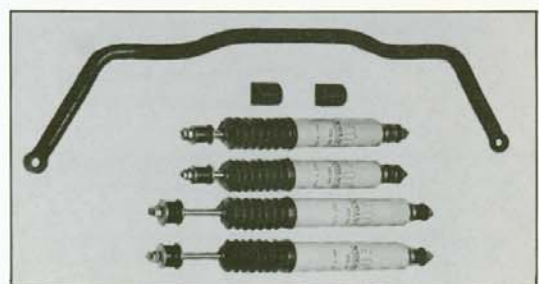
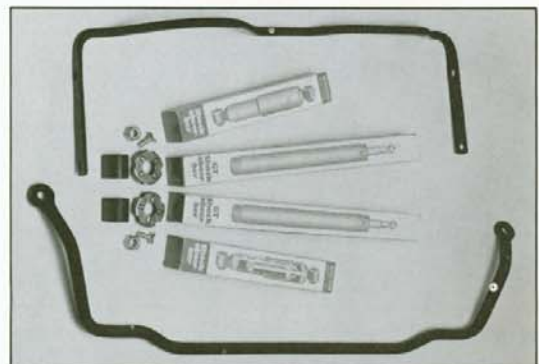
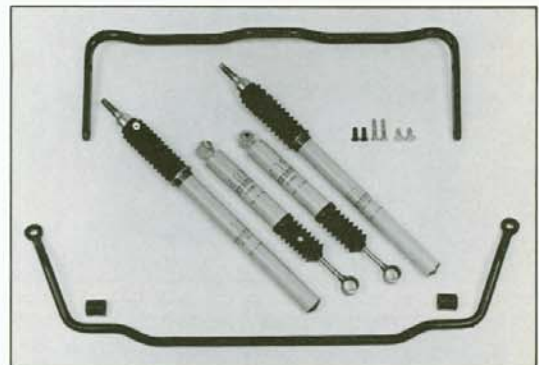
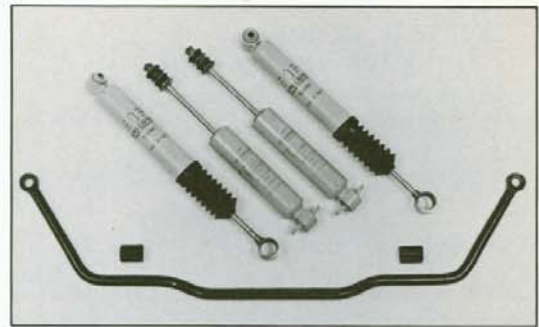

# suspension



## SHOCK ABSORBERS

A simple but effective way to improve the handling of a vehicle is to upgrade the quality and dampening characteristics of the shock absorber.

Volvo offers a large variety of shock absorbers to suit both individual driver preference and the most demanding road conditions.

Two basically different types of shock absorbers are available; the GT shock is designed like the production hydraulic shock, but with firmer dampening characteristics, while special gas pressure shock absorbers offer exceptional fade-free dampening and extreme durability.



## GT Shock Absorbers

Part No.	Qty.	Description	Application
282697-2	2	Front GT Shock	1967-75 140/160
*282698-0	2	Rear GT Shock	1967-75 140/160
283085-9	2	Rear GT Shock	1975-77 240/260
273662-7	2	Front GT Shock	1975-79 240/260
1128656-4	2	Rear GT Shock	1978-79 240/260

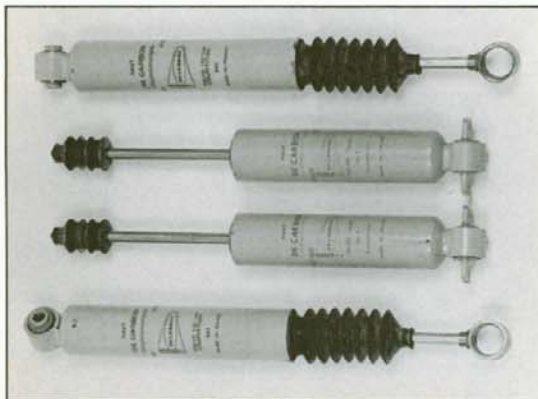

## RALLY GAS PRESSURE SHOCK ABSORBERS

Gas pressure design utilizes single monotube construction for fast heat dissipation and superior fade free performance. Unique design provides for a comfortable ride during normal street driving, but becomes progressively firmer the more they are used. The only shocks recommended for performance rally and racing.

Part No.	Qty.	Description	Application
552199-2	1	Gas Shock Kit	1962-68 120 series 1962-73 1800 series. Moderately firm for road and rally.

Above kit contains following:

552187-7	2	Front Gas Shock
552188-5	2	Rear Gas Shock

552186-9	1	Road Gas Shock Kit	1967-74 140/160 series. Moderately firm for road.
----------	---	--------------------	---

Above kit contains following:

552191-9	2	Front Gas Shock
*552192-7	2	Rear Gas Shock

552185-1	1	Rally Gas Shock Kit	1967-74 140/160 series. Extra firm setting for rally and racing.
----------	---	---------------------	--

Above kit contains following:

552189-3	2	Front Gas Shock
*552190-1	2	Rear Gas Shock

552093-7	1	Road Gas Shock Kit	1975-79 240/260 series. Moderately firm setting for road and rally.
----------	---	--------------------	---

Above kit contains following:

552195-0	2	Front Gas Shock
552196-8	2	Rear Gas Shock

\*All 140/160 models up to 1972 must use late type lower rear shock mount. An adaptor kit is available under part number 282761-6.

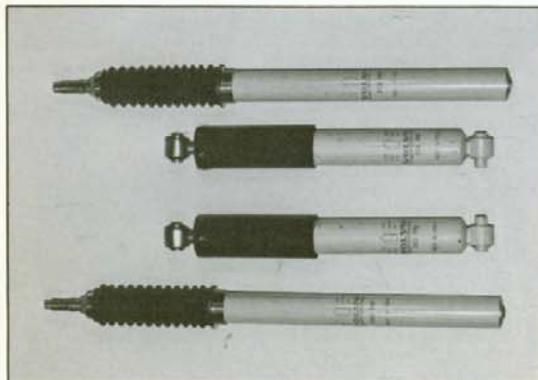



## OVERLOAD SHOCKS

Heavy duty rear shocks utilizing auxiliary coil springs to keep ride height the same while carrying heavy load or towing trailer.

Part No.	Qty.	Description	Application
282877-0	2	Spring Shock	1971-74 140/160
283088-3	2	Spring Shock	1975-79 240/260 1975 164

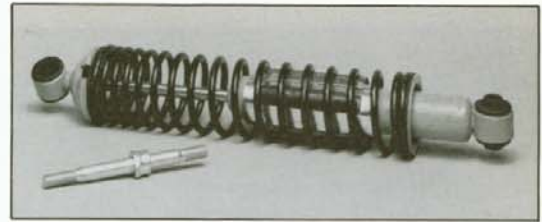

## LOAD LEVELER SYSTEMS

Two systems, either manual or semi-automatic, utilize rear air shocks to control ride height of car. When not carrying heavy loads or towing, ride comfort and height can be returned to normal in seconds.

Part No.	Qty.	Description	Application
283631-0	1	Semi-Automatic System	1975-79 240/260
283632-8	1	Manual System	1975-79 240/260

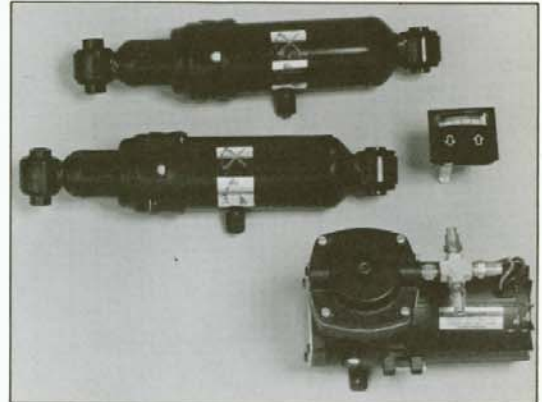

## FULLY AUTOMATIC LEVELING SYSTEM

Unique principle automatically compensates for load by constantly maintaining standard ride height. The heavier the load, the firmer the dampening, yet softer than a standard wagon shock when unloaded. 'Self-compensating damping' also reduces body roll in corners, thus improving roadholding.

Complete with two shock absorbers and two rear springs. Standard on 1979 265.

Part No.	Description	Application
1128791-9	Automatic Shocks	245 1979

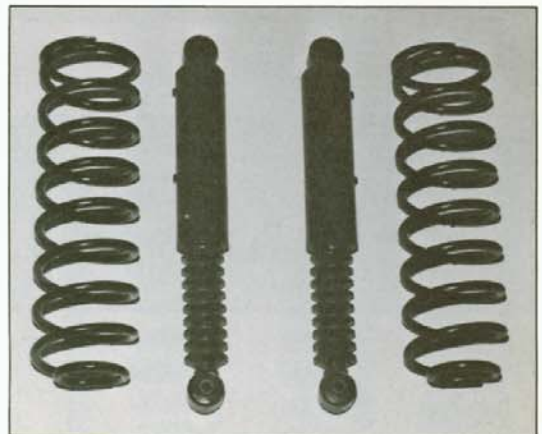

## ANTI-SWAY BARS

Anti-sway bars, or stabilizers, contribute dramatically to the roll stiffness of a vehicle. It is this roll stiffness that affects the handling characteristics of a car and improves its roadholding capability.

The larger the anti-sway bar, the more roll stiffness is added and, consequently, the firmer the ride. However, too much roll stiffness, particularly at one end of the vehicle, can cause unpredictable and unsafe handling and possibly damage other suspension components.

Volvo anti-sway bars have undergone extensive development and testing to insure maximum road holding capability while still retaining vehicle predictability for the driver. While experienced race and rally drivers will often change anti-sway bars for different road conditions, it is recommended that the average driver follow suggestions outlined.

Larger anti-sway bars add further resistance to body roll, thus reducing the lean of the car during hard cornering. Also, vehicle sensitivity to crosswinds is decreased while adding improved stability in all conditions. A larger anti-sway bar fitted to the front will reduce the tendency of the outside front tire to roll over onto its side wall during hard cornering. Unfortunately, adding a very large bar to the front increases both ride stiffness and understeer, as it is effectively reducing the attributes of independent front suspension.

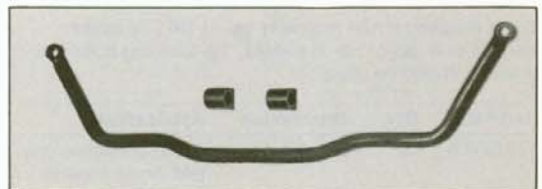

# suspension

## ANTI SWAY BARS

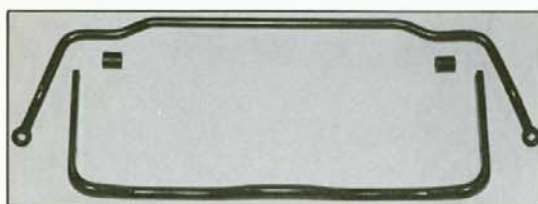
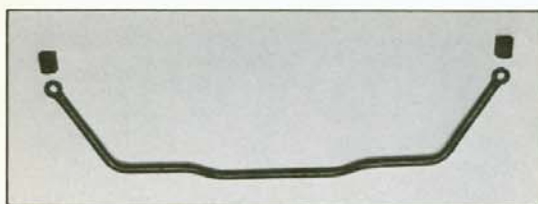

To off set the heavy understeer, a rear anti-sway bar is sometimes added (depending on bar size and car model) so that a neutral or oversteering attitude is obtained.

Part No.	Qty.	Description	Application
659866-8	1	24mm Front Anti-sway Bar	1962-68 120 1962-73 1800 Replaces std. 20mm for increased roll stiffness on road or rally.
659869-2	2	24mm Bushing	To be installed with 24mm front anti-sway bar.
552172-9	1	20mm Front Anti-sway Bar	1967-74 140 Replaces std. 15mm bar for increased roll stiffness on road and rally.
552173-7	2	Bushing	To be installed with 20mm anti-sway bar.
552175-2	1	25mm Front Anti-sway bar	1967-74 140 Recommended for racing or smooth roads only. Substantial reduction in body roll but ride stiffness and understeer noticeably increased. Rear anti-sway bar should be added for neutral handling characteristics.
552176-0	2	Bushing	To be installed with 25mm anti-sway bar.
552096-0	1	Anti-sway Bar Kit	1975-76 240 Includes 21mm (4/5") front and 25mm (1") rear anti-sway bars to replace std. 18mm front and 16mm rear anti-sway bars. Reduces body roll in cornering and adds greater stability in crosswinds. Handling becomes more neutral without sacrificing ride comfort.
552097-8	1	21mm Front Anti-sway Bar (included in kit 552096-0)	1975-79 240 Replaces 18mm std. front bar for increased roll stiffness.
552098-6	1	25mm Rear Anti-sway bar	1975-76 240/260 with exhaust pipe over rear axle. Should only be used on sedans fitted with 21mm front bar. Changes handling to neutral and slight oversteer.
1228839-5	1	21mm Front Anti-sway Bar	1976-79 260 Replaces std. 18mm front bar for increased roll stiffness.
1228841-1	2	Bushing	For 21mm front bars.
1229956-6	1	19mm Rear Anti-sway Bar	Std. on 1979 models but recommended for 1977-78 station wagons not fitted with rear anti-sway bars. Should only be used in conjunction with 21mm front bar or excessive oversteer will result.
1221797-2	1	16mm Rear Anti-sway Bar	Std. on 1975-76 sedans but recommended for 1975-76 wagons when 21mm front anti-sway bar is added.
1229957-4	1	23mm rear Anti-sway Bar	Std. on 1979 242 GT but recommended for all 1977-78 240/260 sedans when 21mm front anti-sway bar is added.

### Rear Anti-Sway Bar Installation Kit

When installing a rear anti-sway bar in 1975-78 station wagons or a larger bar in sedans, the following bolts and brackets should be used.

Part No.	Qty.	Description	Application
1221956-4	2	Bracket	240/260 wagons only (std. on all sedans)
949349-5	2	Bolt	All 240/260
945409-1	2	Nut	Wagons only
955356-1	2	Bolt	All 240/260



## SPRINGS

## suspension

Competition springs can serve two entirely different purposes. To improve roadholding, such as in racing, the spring is made stiffer for increased roll resistance, and shorter for a lower center of gravity.

In rally, the spring is made stiffer but taller to increase ride height for protection from rocks and increase suspension travel to prevent damage from suspension bottoming.

Springs, unfortunately, have a much greater affect on ride comfort than do shocks and anti-sway bars. The shorter and more stiff the spring, the worse the ride becomes.

To overcome this problem, Volvo designed most competition springs with the "progressive rate" principle. That is, the rate or stiffness of the spring progressively increases as the spring is compressed. It is accomplished through the costly process of varying the steel's diameter throughout the spring. This results in a relatively comfortable ride during normal driving but provides the necessary stiffness for large bumps and hard cornering.

Part No.	Qty.	Description	Application
525060-0	2	Front Progressive Rate Spring	1962-68 120 1962-73 1800* Excellent for street and rally use. Approx. 20% stiffer. Ride height remains the same.
525061-8	2	Rear Progressive Rate Spring	1962-68 120 1962-73 1800 Should be used in conjunction with front progressive rate spring. Excellent for handling heavy loads in 120 and 1800. Increases rear ride height 1".

\* 1800 top spring holder requires modification before rally spring can be correctly installed.

552105-9	2	Front Progressive Rate Spring	1967-74 140 Excellent for road and smooth rally. 15% stiffer. Ride height remains std.
552106-7	2	Extra Tall Front Progressive Rate Spring	1967-74 140/164 Recommended for rough rally or off-road use only. 25% stiffer. Increases ride height 3".
552135-6	2	Front Progressive Rate Spring	1969-75 164 Recommended for road and smooth rally 10% stiffer. Ride height remains std.
552137-2	2	Rear Progressive Rate Spring & Installation Kit	1967-73 140/160 Recommended for rally use and vehicles with heavy loads. 15% stiffer, raises ride height 2" in rear. Installation kit keeps spring in place during jumps in rally.
552136-4	2	Rear Progressive Rate Spring without Installation Kit	1974-79 140/160/240/260 Recommended for rally and off-road use or any vehicle with heavy rear loads. 15% stiffer. Increases ride height 2" in rear.
552134-9	2	Front Road/Rally Spring	1967-75 140/164 Non-progressive, 70% stiffer front spring for smooth rally roads and street use. Ride height remains same in 140 & decreases 2" in 164.
552128-1	2	Rear Road/Rally Spring	1967-73 140/160 Best for road use where 1 1/2" reduction in rear ride height is desired. 10% stiffer.
1229337-9	2	Front GT Springs	1975-79 240/260 Non-progressive, 35% firmer than standard. Ride height remains same. Standard on '79 242 GT.

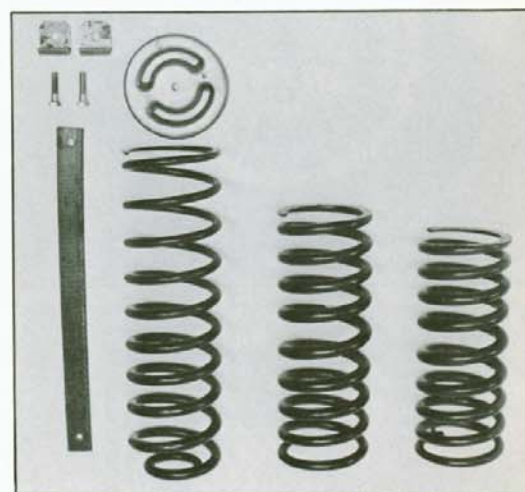
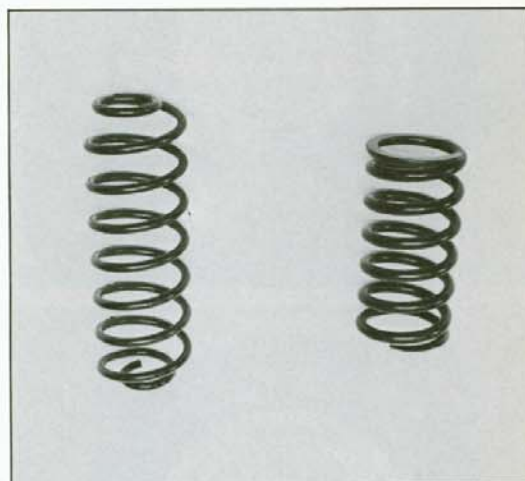

# suspension

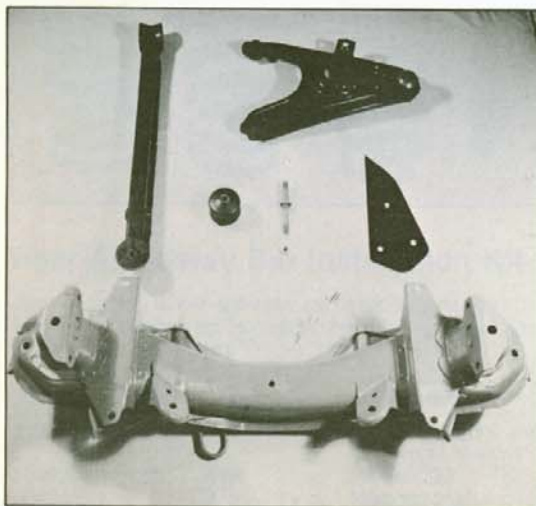
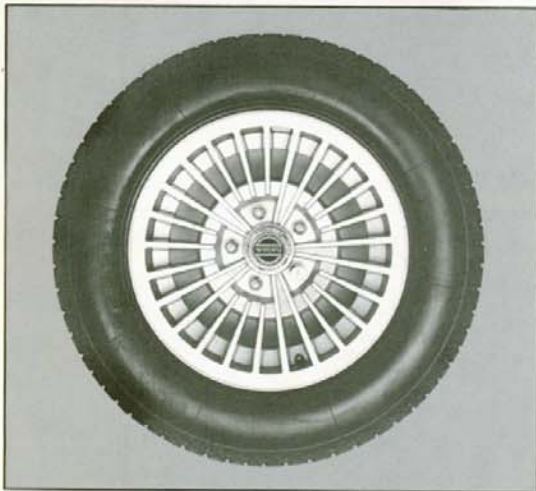
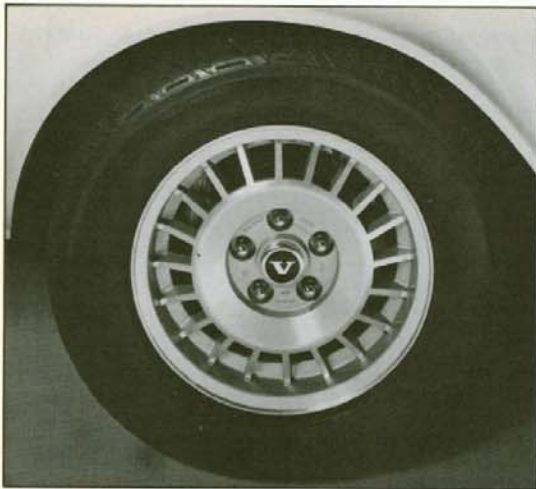

## ALLOY WHEELS

High strength aluminum alloy wheels weigh only 12½ pounds, reducing unsprung weight by 7 pounds per wheel. This means more responsive roadholding and increased ride comfort.

The 5½ "x14" wheels are available in a variety of designs that not only look good, but also allow increased air flow and faster heat dissipation for superior brake cooling.

Part No.	Qty.	Description	Application
1128493-2	4	GT Wheel	1975-79 240/260
1128730-7	4	Finned Wheel	1975-79 240/260
1128492-4	4	Small Hub Cap for Finned Wheel	1975-79 240/260
1129031-9	4	Large Hub Cap for Finned Wheel	1975-79 240/260
688984-4	20	Chrome Lug Nuts	Must be used with all alloy Wheels
1128758-8		Set of 4 Anti- Theft Wheel Locks	1975-79 240/260

## REINFORCED SUSPENSION PARTS

European performance rallies are perhaps the most grueling test of a cars strength and durability.

The 140 series is one of the strongest and most popular cars used in European rallies, but unsuspecting rocks and off-road excursions can bend even the best of cars.

To prevent early retirement from such mishaps, Volvo's competition department has developed a small but very important range of special suspension parts.

Part No.	Qty.	Description	Application
552130-7	1	Front Axle Crossmember	1967-74 140 Internally and externally reinforced. Recommended for all rally and off-road cars.
552131-5	1	Reinforced Lower Left A-arm	1967-74 140 Prevents flexing and bending in off-road use.
552132-3	1	Reinforced Lower Right A-arm	Same as above.
552138-0	2	Reinforced Rear Support Arm	1971-74 140/160 Prevents flexing and bending in off-road use and racing.
552140-6	2	Extra Hard Rubber Bushing for Rear Support Arms	1967-74 140/160 Eliminates flex and sway in rear suspension. Recommended for hard street driving, rally and racing.
552141-4	2	Lower Mounting Bolt for Shock Absorber	1967-74 140/160 Extra hard stainless steel bolt. Recommended for rally and race cars using firmer shocks.
552142-2	2	Reinforcement Plate for Rear Support Arms	1967-74 140/160 Eliminates flex and wear between rear support arm and body frame, especially with harder bushing. Essential for rally and race.



## RALLY PROTECTION PLATES

Light but specially hardened aluminum protection plates to protect engine and gearbox from rock damage. Specifically designed for each model to insure easy installation and add rigidity to front sub-frame.

Part No.	Description	Application
552111-7	Front Protection Plate	1962-68 120 series 1962-73 1800 series Weight 39 Lbs.
552112-5	Rear Protection Plate	1962-68 120 series 1962-73 1800 series Weight 24 Lbs.
552113-3	Front Protection Plate	1967-70 140 series Weight 44 Lbs.
552116-6	Front Protection Plate	1971-74 140 series Weight 44 Lbs.
552114-1	Rear Protection Plate	1967-73 140/160 Weight 17½ Lbs.
552117-4	Rear Protection Plate	1971-73 140/160 with electric fuel pump (E.F.I.) Weight 28½ Lbs.
552118-2	Rear Protection Plate	1974 140/160 Weight 44 Lbs.
552221-4	Fuel tank Spacer Frame	1967-73 140/160 Eliminates need for rear protection plate by lifting gas tank into trunk.

## SPOILERS

Front spoilers are available in various designs and colors for most Volvo models. Whether made of economical fiberglass or flexible impact resistant plastic, Volvo spoilers are designed for that attractive GT look while increasing stability and fuel economy at highway speeds.

For racing and rallying, it means a higher top speed and nose down stability in the long straights.

Each spoiler is complete with installation instructions and mounting hardware.

Part No.	Description	Application
552165-3	120 Front Spoiler	1962-68 120 series Made of black fiberglass. Attaches directly to body with front bumper removed.
552166-1	140 Front Spoiler	1967-74 140 series Made of black fiberglass but can be painted any color. Attaches to front body apron but front bumper can remain.
552168-7	240/260 Front Spoiler	1975-79 240/260 Made of black fiberglass. Mounts to bottom of bumper.
1128485-8	Black GT Spoiler	1975-79 240/260 Identical to spoiler on 242GT but painted black. Made of flexible impact resistant plastic.
1128653-1	Silver GT Spoiler	1975-79 240/260 Identical to 242GT spoiler except without stripes. Made of flexible impact resistant plastic.
1128486-6	Black Spoiler Stripe	Fits around leading edge of GT spoiler.
1128654-9	Silver Spoiler Stripe	Same as above.

**VOLVO**  
body

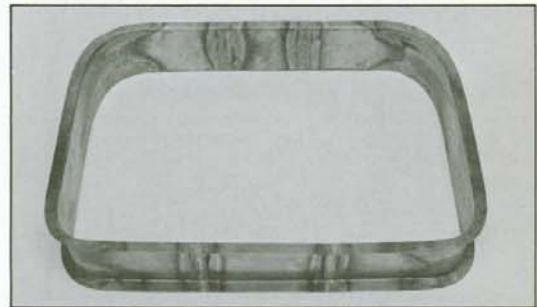
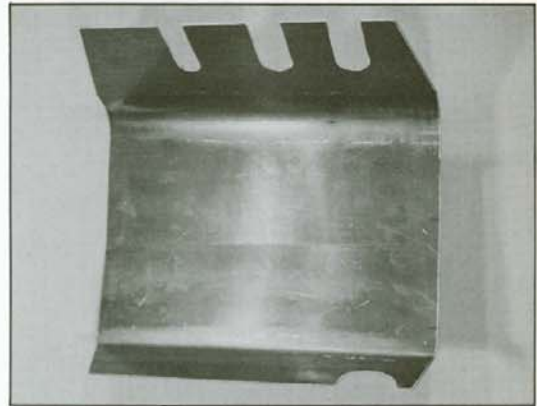
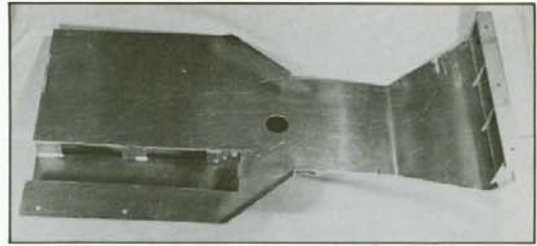

# body



## STRIPES

Sporty side stripes that follow along the entire length of the car above the side mounting. Available in deep black or metallic silver.

Part No.	Description	Application
1128494-0	Silver, above side molding	1975-79 242/262
1128495-7	Black, above side molding	1975-79 242/262
1128496-5	Silver, above side molding	1975-79 244/264
1128497-3	Black, above side molding	1975-79 244/264



Simulated teakwood grain pattern adds that "country estate" appearance to all wagons

Part No.	Description	Application
1128503-8	Teakwood, above side molding	1975-79 245/265



Short side stripe adds sporty image to all four door models. Available in black.

Part No.	Description	Application
1128501-2	Short Stripe	1975-79 244/264



Rally flair stripe runs along bottom third of all models to add unique Rally look.

Part No.	Description	Application
552306-3	White Stripe	1967-79 140/160/ 240/260
552307-1	Black Stripe	1967-79 140/160/ 240/260



# VOLVO miscellaneous accessories

## STEERING WHEELS

Three distinctively different 'sport' type steering wheels to suit your own personal taste.

The GT Wheel, standard on the 242 GT, adds that exclusive GT look to all current Volvo models. Small 14½ inch rim covered in thick imitation leather has matching interior grain pattern. Improves steering response and increases leg room.

The R Sport Wheel is designed for race and rally drivers who demand only the best. Top quality genuine leather wraps the thick outer rim for exceptional looks and feel.

Wide-spaced spokes and small center hub allows for fast, unobstructed movement of the hands. Special collapsible center meets North American safety regulation (FMVSS 203) and is the only competition steering wheel approved by Volvo.

Both the three and four spoke design use a smaller rim diameter to effectively quicken the steering ratio, and each is specially weighted for accurate feedback and wheel return. Complete with horn and installation instruction.

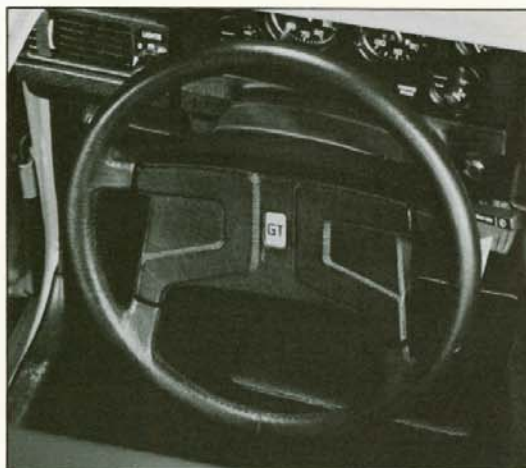

Part No.	Description	Application
552032-5	Three Spoke 13¾" diameter	All 120 models
552033-3	Three Spoke 13¾" diameter	1967-1972 140 and 164 models
552034-1	Three Spoke 13¾" diameter	1973-74 140 1973-75 164 1975-78 240/260
552035-8	Four Spoke 15" diameter	1973-74 140 1973-75 164 1975-78 240/260
1128127-6	GT Steering Wheel 14½" diameter	1976-79 240/260
552344-4	Three Spoke 13¾" Diameter	1979 240/260
552345-1	Four Spoke 15" Diameter	1979 240/260



## GT GEAR SHIFT KNOB AND BOOT

Simulated leather matches GT steering wheel for the totally integrated GT look.

Part No.	Description	Application
1128144-1	Shift Knob 4 speed without overdrive only.	1975-79 240/260
1264664-2	Leatherboot	All 240/260 with manual gear box



## miscellaneous accessories



### RALLY SEAT

Top quality light weight construction by Recaro featuring superior lateral support makes this the ideal seat for rally and racing.

Black corduroy material with padding insures both comfort and fast moisture evaporation.

Part No.	Application
552305-5	all 140/160/240/260



### SKI JACKETS & PANTS

The all new top-of-the-line "Volvo R Team" Ski and Rally Jacket. The most sought after official factory racing jacket on the European Rallycross circuit today!

Exclusive European tailoring gives this heavy ski-like jacket a look all its own. Distinctively black with warm yellow inner lining and blue and yellow stripes along the sides. Features a full-length, two-way zipper for easy driving, a padded button-down collar, three outer pockets with zippers, one inner pocket with button, a pen pocket on the left arm, snow-lock cuffs in the arms, and a discrete "Volvo R Sport" emblem on the left shoulder.

If that's not enough, matching black ski pants with front zipper pocket and the R Sport emblem are also available. Made of the same high quality materials and European craftsmanship.

Perhaps the most distinctive combination ever seen on a ski slope!



### SWEATERS

The very latest fashion in automotive sportswear... pullover knit sweaters. Made in Sweden exclusively for Volvo with warm but light weight 100% Acrylic Fiber.

Available in two distinctive styles; one in light blue with 'Volvo' woven right into the front left chest; the other in deep, rich black with 'R Sport' printed on the front and the Swedish colors, blue and yellow, woven into the left arm.

An exceptional value that says it's uniquely yours, but practical enough for everyday use.



## miscellaneous accessories

### JACKETS

Medium weight rally jacket of 100% water repellent nylon in Volvo blue, two white vertical stripes on the right front side with the "Volvo" badge sewn on the left. Lining is made of warm white nylon fleece and quilt lined sleeves. Two button collar and cuffs along with two front pockets. Machine washable with a twelve month warranty against defects in materials or workmanship.

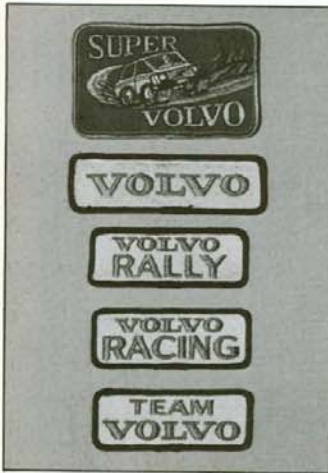

### JACKET PATCHES



### T-SHIRTS



Items listed in the clothing section are representative samples of Volvo sportswear and may not be available exactly as shown. Due to frequent seasonal changes in the textile industry, it is impossible to include all current styles and colors and eliminate those that have discontinued. Contact an authorized Volvo dealer for the most current listing of Volvo sportswear.

# miscellaneous accessories

## SAFETY HELMETS

The most respected name in Motocross riding equipment now offers Jofa Safety Helmets for the motorsport enthusiast.

Superior construction and design of the Jofa helmet places it in a performance league that very few manufacturers can match. Not only do they have The Snell Memorial Foundation/DOT 1975 approval, but they also meet the Ansi Std. Z90-1-1971 and carry the tough new 1979 DOT approval.

Besides offering the highest possible protection that technology can offer today, Jofa helmets are substantially lighter than equivalent models of other brands. Just 44 ounces for the open face model and 51 ounces for the full-face.

Exceptional strength, comfort, visibility, and styling make the Jofa helmet an extraordinary value.

Available in two models and seven striking colors.

### FULL FACE HELMETS

Part Number	Size	Color
1128900-6	Small	Red
1128901-4	Medium	Red
1128902-2	Large	Red
1128903-0	X-Large	Red
1128904-8	Small	Blue
1128905-5	Medium	Blue
1128906-3	Large	Blue
1128907-1	X-Large	Blue
1128908-9	Small	Yellow
1128909-7	Medium	Yellow
1128910-5	Large	Yellow
1128911-3	X-Large	Yellow
1128912-1	Small	Orange
1128913-9	Medium	Orange
1128914-7	Large	Orange
1128915-4	X-Large	Orange
1128916-2	Small	Black
1128917-0	Medium	Black
1128918-8	Large	Black
1128919-6	X-Large	Black
1128920-4	Small	White
1128921-2	Medium	White
1128922-0	Large	White
1128923-8	X-Large	White
1128924-6	Small	Silver
1128925-3	Medium	Silver
1128926-1	Large	Silver
1128927-9	X-Large	Silver

### OPEN FACE HELMETS

Part Number	Size	Color
1128928-7	Small	Red
1128929-5	Medium	Red
1128930-3	Large	Red
1128931-1	X-Large	Red
1128932-9	Small	Blue
1128933-7	Medium	Blue
1128934-5	Large	Blue
1128935-2	X-Large	Blue
1128936-0	Small	Yellow
1128937-8	Medium	Yellow
1128938-6	Large	Yellow
1128939-4	X-Large	Yellow
1128940-2	Small	Orange
1128941-0	Medium	Orange
1128942-8	Large	Orange
1128943-6	X-Large	Orange
1128944-4	Small	Black
1128945-1	Medium	Black
1128946-9	Large	Black
1128947-7	X-Large	Black
1128948-5	Small	White
1128949-3	Medium	White
1128950-1	Large	White
1128951-9	X-Large	White
1128952-7	Small	Silver
1128953-5	Medium	Silver
1128954-3	Large	Silver
1128955-0	X-Large	Silver







An "R Team" 343 becomes airborne during European Rallycross Championship.

The extensive range of Volvo Accessories does not end here. More than 200 additional accessories, ranging from Air Conditioning to Trailer Hitches, are listed in a separate Accessories Brochure available free of charge from all authorized Volvo dealers.

In addition to the brochure, the Parts Department of each dealer maintains separate Accessory and R Sport loose-leaf catalogs that are continuously up-dated with the latest in new product information.

The Volvo dealer is your exclusive source for genuine Volvo Parts. Protected by a limited 12 month warranty, genuine Volvo Parts assure you of unsurpassed performance and quality that keeps your Volvo going better longer.

Volvo R Sport can provide technical information only for Performance Parts and GT Accessories. The most comprehensive source for other technical and service information is the factory Service Manual. A wide selection of manuals covering most years and models are available through your local Volvo dealer.



**VOLVO**  
VOLVO NORTH AMERICA  
PARTS DIVISION